

**TATA STEEL**



**Trisomet®**  
External roof and wall panel system



# Contents

- 4-5 Introduction and benefits
- 6 Platinum Plus® system guarantee
- 7 Colorcoat® products and services
- 8-10 System performance data
- 11 Summary of Building Regulation requirements for the conservation of fuel and power
- 12-13 Roof application model specification
- 14-24 Roof construction details
- 25 Jaffabox case study
- 26-27 Wall application model specification
- 28-38 Wall construction details
- 39 Fasteners, sealants and fillers
- 40-41 Site guidance
- 42-43 Roof installation
- 44-47 Wall installation





# Tata Steel

**Tata Steel is Europe's second largest steel producer. Our comprehensive range of high quality products and services are supported by steel making sites in the UK and The Netherlands, a European-wide distribution and service centre network and downstream businesses ranging from tubes and building systems to plating.**

Our approach to business is unique. We believe our strength is how we build collaborative relationships that create new success for our customers, adding value to their business and helping them to perform in their markets. As a company, we are dedicated to managing our operations responsibly and to continuously improving our performance. We operate in a way that is safe for our people and which respects the environment, with care towards the communities surrounding our operations and beyond.

## Sustainability

Steel is an essential material, intrinsic to our way of life and to the products society will demand in a sustainable future. Steel is a material that is used, not consumed. It is recycled and used again, without any loss of quality, time after time. At Tata Steel, we are committed to making the products society

needs and to making them in the most responsible way possible.

This means, practically, that we commit to:

- Producing steel products for the future.
- Investing in sustainable steel making.
- Improving our existing processes.
- Facilitating the recycling loop.

## Building envelope

Tata Steel has extensive panel and profiling manufacturing capabilities. We are the only company able to offer a comprehensive range of insulated panels, built-up systems, façades, structural roof and floor decking profiles from one single UK source, with the support and backing of a truly global company and complete supply chain.

With such a diverse product portfolio and 50 years experience, we are uniquely able to offer the specifier an unbiased solution to meet the design criteria for any project.

# Trisomet®

Trisomet® is an insulated panel manufactured as a single component suitable for both roof and wall cladding applications. As a one-fix component its consistency enables speed of installation and with a wide spaced trapezoidal steel external skin provides optimum performance for water drainage, strength and walkability.

## Technical Services

Our dedicated building envelope technical team are available to provide support and advice on the best product for your project. They are on hand to help with:

- Detail design.
- Wind and snow loading.
- U-value calculations.
- Load span checks.
- Acoustic SRI predictions.
- Specification writing.
- Advice on meeting Building Regulations, maximising BREEAM credits.
- Assistance with SBEM.
- Condensation risk analysis.
- Assistance in product testing.

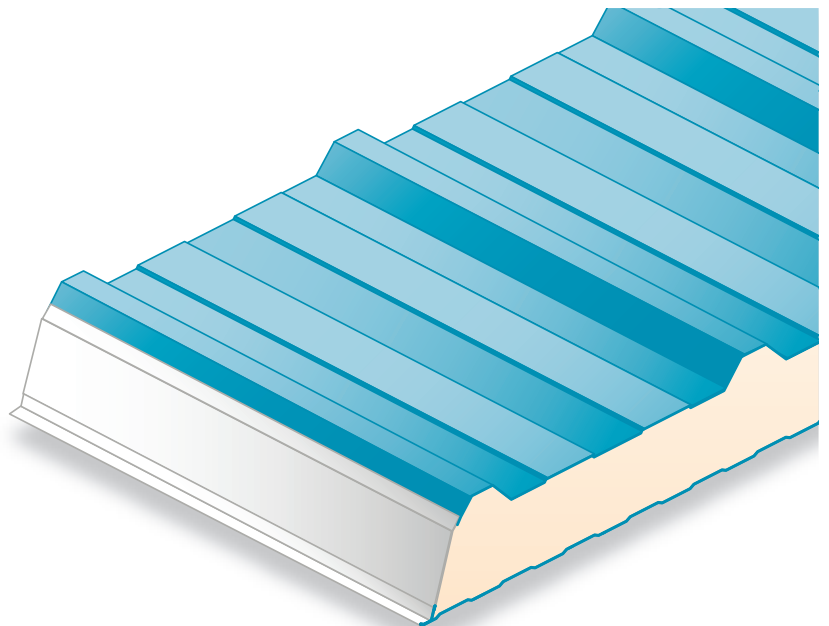



## Case study

### Llanwern House, Llanwern Works, Newport

Llanwern House, the new, energy efficient reception hub at Tata Steel's Llanwern Works in Newport, features a cavalcade of our building envelope and structural solutions.

The building has been entirely constructed using solutions by Tata Steel and has three floors.

The ground floor will house conference facilities as well as a visitors' induction area. Floor One and Two feature an open-plan working environment, housing 200 employees.

---

Client: Tata Steel

---

Architect: Boys Rees

---

Main contractor: Dawnus

---

Envelope installer: Coverstructures South West Ltd

---

Decking installer: Composite Profiles Ltd

---

Cladding system: Trisobuild®, Trisomet®, Stratascreen®, C32 Profile and WP40 Profile

---

Decking system: ComFlor® 80

---

Colorcoat® product: Colorcoat Prisma®

---

#### Key benefits: Trisomet®

- One fix construction in panel lengths from 300 mm to 20 m to optimise speed of installation and minimise waste for more sustainable construction.
- Core depths from 40 to 135 mm to optimise the design solution. The 135 mm core meets a U-value of 0.15 W/m<sup>2</sup>K.
- Third party validation of high standards of quality, thermal performance, fire safety, acoustic performance, air-tightness, water penetration and environmental credentials.
- Approved to FM Class 4880, 4881 and 4471 to an unlimited wall height.
- LPCB (Loss Prevention Certification Board) approval to LPS 1181 Part 1 to help reduce insurance premiums and assures reaction to fire performance.
- Fire resistance performance of up to 30 minutes insulation and 4 hours integrity achievable with standard fixing and sealing methods (external side-lap stitched at maximum 300 mm centres).
- Available with Platinum Plus® system guarantee for 25 years, covering a pre-approved range of reputable, high-end components.
- Colorcoat HPS200 Ultra® or Colorcoat Prisma® pre-finished steel used as standard, offering long-term performance with the Confidex® Guarantee and providing peace of mind for up to 40 years.
- Easy installation of photovoltaic (PVs) when used as a roof panel. Scheme specific specifications and funding options can be discussed using PV panels from Tata Power.
- When used in conjunction with Colorcoat HPS200 Ultra®, PV modules can be installed at any point throughout the Confidex® duration and will be covered for the remainder of the guarantee period. Future proofing your building so that it is PV ready.
- Manufactured in factory conditions operating to quality management standard BS EN ISO 9001:2008 and environmental management standard BS EN ISO 14001: 2004.
- Product specification and performance in accordance with BS EN 14509, European Product Standard for CE Marking.
- Full traceability of all component materials and certified 'very good' to BRE's responsible sourcing standard BES 6001.
- Certification to BES 6001 provides independent evidence of our corporate responsibility, and helps increase credits under the Responsible Sourcing of Materials section of BREEAM.
- The state of the art PIR core has zero ozone depletion potential (ODP) and a very low global warming potential (GWP) of less than 5 to increase BREEAM credits.





Client: Wm Morrison Supermarket Plc

Architect: RPG Architects

Main contractor: Bamwood Construction Ltd

Cladding system: Trisomet® and Trimapanel®

Colorcoat® product: Colorcoat HPS200 Ultra® in Goosewing Grey and Colorcoat Prisma® in Silver Metallic

## Platinum Plus® system guarantee

Platinum Plus® provides a complete building envelope solution guaranteed for 25 years.

Designed in collaboration with our innovative supply chain of leading component manufacturers, our comprehensive portfolios of high quality products are fully integrated to provide the widest range of roofing and cladding systems.

The Platinum Plus® guarantee includes, amongst others, the following components:

- Trisomet® insulated panel.
- Colorcoat HPS200 Ultra® or Colorcoat Prisma® pre-finished steel.
- Stainless steel fixings.
- Roof lights.
- Sealant.
- Fillers.
- Fall arrest systems.
- Flashings and gutters.

The guarantee is offered directly to building owners, giving a direct link back to Tata Steel as the one point of contact.

For full details of our approved components please contact our technical team on T: +44 (0) 1244 892199.

To ensure that the building envelope will perform as required by the client, we work with specifiers to tailor a specification that considers the interactions of the components and how they impact the building design and performance. We will then provide a detailed Platinum Plus® specification for use within the project tender package, together with a list of recommended installation contractors.

To guarantee the quality of components used on your building, our team of technical

construction experts will visit the site to check for compliance to specification, reducing the risk of any issues arising in the future.

Once the project is completed the installer will be required to apply for the guarantee using the supplied forms included in the specification document. Tata Steel will then issue the Platinum Plus® guarantee directly to the building owner.

### How to raise a specification?

The Platinum Plus® system guarantee needs to be registered with the specifier prior to the tender package being distributed. Please contact our technical team so that we can help you to guarantee the longevity of your building on T: +44 (0) 1244 892199.



# Colorcoat® products and services

Trisomet® is only supplied with Colorcoat® pre-finished steel for the external and internal skin so that we can provide the very highest quality and service to our customers.

## Colorcoat® products and services

The Colorcoat® brand provides the recognised mark of quality and metal envelope expertise exclusively from Tata Steel. For 50 years Tata Steel has developed a range of technically leading Colorcoat® pre-finished steel products which have been comprehensively tested and manufactured to the highest quality standards. Colorcoat® products manufactured in the UK are certified to BES 6001 Responsible Sourcing standard.

## Colorcoat HPS200 Ultra®

The latest generation product for roof and wall cladding, Colorcoat HPS200 Ultra® is the only pre-finished steel product to ensure your building envelope maintains its integrity and aesthetic appeal for up to 40 years with the Confidex® Guarantee with no inspections or maintenance to maintain its validity. For more information visit [www.colorcoat-online.com/ultra](http://www.colorcoat-online.com/ultra)

### Key benefits include:

- Confidex® Guarantee for up to 40 years including cut edges for the weatherside of industrial and commercial buildings.
- 40 standard colours in solid and matt shades.
- Surpasses requirements of Ruv4 and RC5 as per EN 10169:2010 proving outstanding colour retention and corrosion resistance.
- Optimised Galvalloy® metallic coating for exceptional corrosion resistance and cut edge protection.
- Scintilla® embossed as a mark of authenticity from Tata Steel.
- Repertoire® colour matching service for solid colours with a minimum order quantity of 2500 m<sup>2</sup>.
- Exceeds requirements of CPI5 as per EN 10169:2010 demonstrating excellent barrier properties when used internally.

## Colorcoat Prisma®

Designed to withstand the rigours of the external environment, versatile, lightweight and strong, Colorcoat Prisma® pre-finished steel is the ideal choice for your building envelope for long lasting colour. With a contemporary new colour range and an optically smooth finish, inspire your imagination. For more information visit [www.colorcoat-online.com/prisma](http://www.colorcoat-online.com/prisma)

### Key benefits include:

- Confidex® Guarantee for up to 30 years including cut edges.
- 27 standard colours in solid, metallic and matt shades.
- All colours surpass requirements of Ruv4 and RC5 as per EN 10169:2010 proving outstanding colour retention and corrosion resistance.
- Optimised Galvalloy® metallic coating for ultimate corrosion resistance and cut edge performance.
- Reverse side branding making traceability easy, so you can rest assured that your building is protected with the highest quality from Tata Steel.
- Repertoire® colour matching service for solid colours with a minimum order quantity of 2500 m<sup>2</sup>.

## Colorcoat® High Reflect

In addition to the standard liner, we also offer the Colorcoat® High Reflect as an option.

### Key benefits include:

- ≥ 85 % reflectance, reducing the amount of energy required to achieve the same level of lighting.
- Possible energy savings of up to 12% per year.
- Significantly reduces CO<sub>2</sub> emissions by 2-3% per year, helping you to achieve compliance with tightening regulations.

## Confidex® Guarantee

Offers the most comprehensive guarantee for pre-finished steel products in Europe and provides peace of mind for up to 40 years. Unlike other guarantees, Confidex® covers cut edges for the entirety of the guarantee period with no inspection or maintenance to maintain its validity.

Includes cover for Colorcoat HPS200 Ultra® pre-finished steel that is under photovoltaic (PV) frame modules, providing the building owner with the confidence that installing a PV array will not have a detrimental effect on the performance of the roof and that the whole roof is guaranteed to perform for the same duration of up to 40 years.



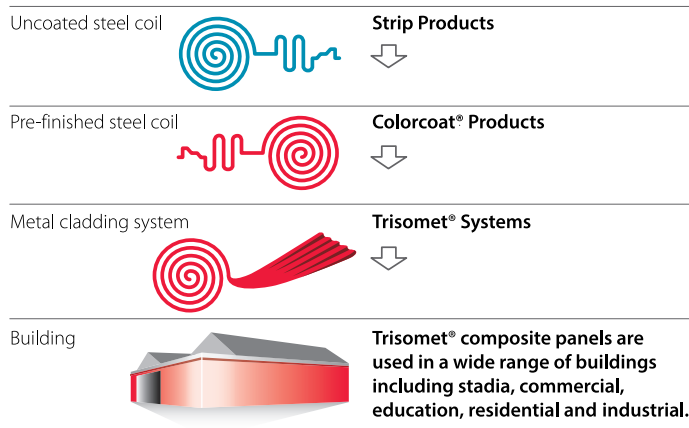

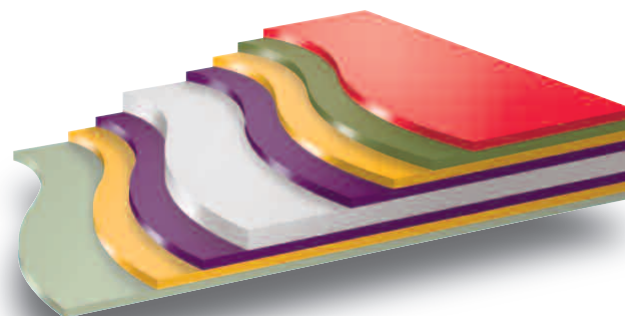

For more information about Colorcoat® products and services call the Colorcoat Connection® helpline on T: +44 (0) 1244 892434.



## Colorcoat® pre-finished steel layers



### Key

 Topcoat	 Primer	 Pre-treatment
 Metallic coating	 Base substrate	 Backing coat

# System performance data

Trisomet®

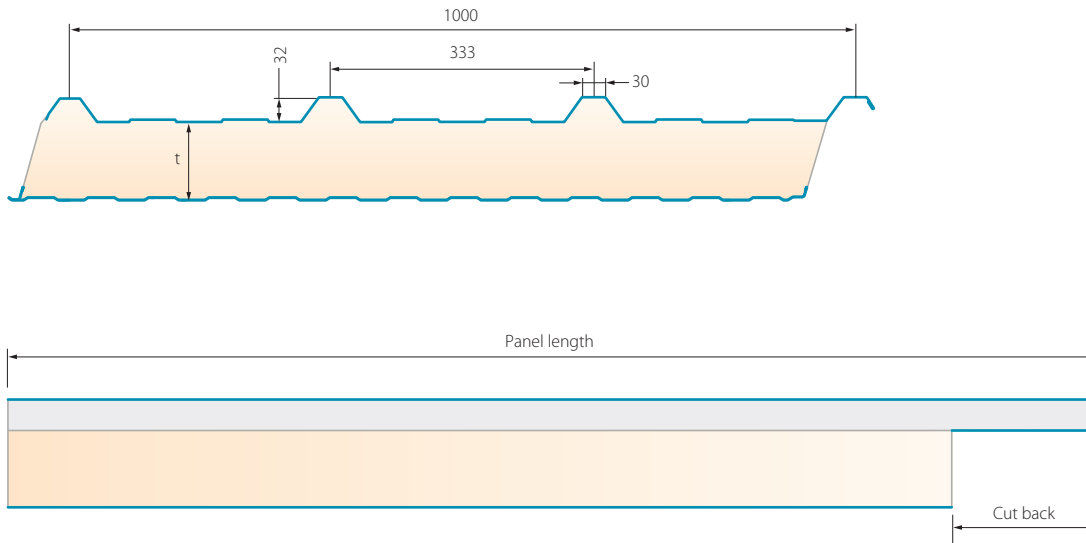

### General panel information

Thickness, t (mm)	40, 60, 80, 100, 120 and 135
Maximum length (mm)*	20000
Minimum length (mm)	300
Cutback (mm)**	
Minimum	25
Maximum	250***
Weight (based on thickness mm) (kg/m <sup>2</sup> )	
40	9.23
60	10.01
80	10.40
100	11.22
120	12.03
135	12.76

\* The panel length is measured by the length of the external sheet, as shown above. Lengths over 14000 mm will be subject to additional delivery charges.

\*\* Panels will always have one flush end and one cutback end; therefore, they will be handed and should be ordered according to the direction of lay required.

\*\*\* Recommended end laps are 50 mm for horizontal, 100 mm for vertical and 150 mm for roof applications.

### Panel manufacturing tolerance

Cover width (mm)	±2
Thickness (mm)	±2
Squareness (mm)	<6
Cutback (mm)	-2 +5
Length (mm) < 3 m	±5
Length (mm) > 3 m	±10

Tolerance is in accordance with BS EN 14509.

### General reference

All measurements throughout this brochure are referenced in mm unless stated otherwise. Technical illustrations are not to scale.



# Span/load tables

The span tables below have been created in accordance with BS EN 14509. The values are based on a 0.5 mm external face, a 2.0 mm minimum purlin thickness, and a maximum permitted cladding deflection of Span/200 under imposed load.

## Safe imposed (positive) loads (kN/m<sup>2</sup>)

Span condition	Core thickness (mm)	Span (m)												
		1.2	1.4	1.6	1.8	2.0	2.2	2.4	2.6	2.8	3.0	3.2	3.4	3.6
Single	40	3.31	2.74	2.32	1.99	1.73	1.51	1.33	1.09	0.88	0.71	0.58	0.47	0.39
	60	4.20	3.59	3.13	2.76	2.45	2.18	1.95	1.69	1.45	1.25	1.08	0.93	0.79
	80	5.10	4.47	3.97	3.55	3.19	2.88	2.60	2.32	2.01	1.76	1.54	1.35	1.20
	100	6.02	5.35	4.81	4.35	3.95	3.59	3.27	2.96	2.60	2.29	2.03	1.80	1.60
	120	6.94	6.25	5.67	5.17	4.72	4.31	3.94	3.60	3.20	2.84	2.53	2.26	2.03
	135	7.64	6.92	6.32	5.78	5.30	4.86	4.44	4.08	3.65	3.26	2.91	2.62	2.36
Double	40	3.06	2.33	1.84	1.50	1.25	1.06	0.91	0.79	0.69	0.61	0.55	0.49	0.44
	60	3.39	2.62	2.10	1.73	1.46	1.24	1.08	0.94	0.84	0.74	0.67	0.60	0.55
	80	3.71	2.90	2.34	1.94	1.64	1.41	1.23	1.08	0.96	0.86	0.78	0.70	0.64
	100	4.00	3.15	2.57	2.14	1.82	1.57	1.37	1.21	1.08	0.97	0.87	0.79	0.72
	120	4.28	3.40	2.78	2.33	1.99	1.72	1.51	1.33	1.19	1.07	0.97	0.88	0.80
	135	4.48	3.57	2.93	2.46	2.11	1.83	1.60	1.42	1.27	1.14	1.03	0.94	0.86
Multi	40	3.31	2.66	2.10	1.71	1.42	1.21	1.04	0.91	0.80	0.71	0.64	0.57	0.52
	60	3.82	2.93	2.34	1.92	1.62	1.39	1.20	1.06	0.94	0.84	0.76	0.69	0.62
	80	4.12	3.19	2.56	2.12	1.80	1.55	1.35	1.19	1.06	0.95	0.86	0.79	0.72
	100	4.39	3.43	2.78	2.31	1.97	1.70	1.49	1.32	1.18	1.06	0.96	0.88	0.80
	120	4.66	3.66	2.98	2.49	2.12	1.84	1.61	1.43	1.28	1.16	1.05	0.96	0.88
	135	4.85	3.83	3.13	2.62	2.24	1.94	1.71	1.51	1.36	1.22	1.11	1.02	0.93

## Safe wind suction (negative) loads (kN/m<sup>2</sup>)

Span condition	Core thickness (mm)	Span (m)												
		1.2	1.4	1.6	1.8	2.0	2.2	2.4	2.6	2.8	3.0	3.2	3.4	3.6
Single	40	-3.45	-2.88	-2.46	-2.14	-1.87	-1.65	-1.47	-1.32	-1.19	-1.07	-0.97	-0.85	-0.73
	60	-4.35	-3.75	-3.29	-2.92	-2.60	-2.34	-2.11	-1.91	-1.73	-1.58	-1.44	-1.32	-1.22
	80	-5.27	-4.63	-4.13	-3.72	-3.36	-3.05	-2.77	-2.52	-2.30	-2.11	-1.94	-1.78	-1.64
	100	-6.20	-5.53	-4.99	-4.53	-4.13	-3.77	-3.45	-3.15	-2.89	-2.66	-2.45	-2.26	-2.09
	120	-7.14	-6.44	-5.86	-5.36	-4.91	-4.50	-4.13	-3.80	-3.49	-3.22	-2.97	-2.74	-2.52
	135	-7.85	-7.12	-6.52	-5.98	-5.50	-5.06	-4.65	-4.28	-3.95	-3.64	-3.36	-3.11	-2.80
Double	40	-3.10	-2.38	-1.91	-1.58	-1.35	-1.16	-1.02	-0.91	-0.82	-0.75	-0.68	-0.63	-0.58
	60	-3.44	-2.68	-2.17	-1.82	-1.55	-1.35	-1.19	-1.07	-0.96	-0.88	-0.81	-0.75	-0.69
	80	-3.76	-2.97	-2.42	-2.04	-1.75	-1.53	-1.35	-1.21	-1.10	-1.00	-0.92	-0.85	-0.79
	100	-4.07	-3.23	-2.66	-2.24	-1.93	-1.69	-1.50	-1.35	-1.22	-1.12	-1.03	-0.95	-0.89
	120	-4.36	-3.49	-2.88	-2.44	-2.11	-1.85	-1.64	-1.48	-1.34	-1.22	-1.13	-1.05	-0.97
	135	-4.57	-3.67	-3.04	-2.58	-2.23	-1.96	-1.74	-1.57	-1.42	-1.30	-1.20	-1.11	-1.04
Multi	40	-3.45	-2.70	-2.16	-1.78	-1.51	-1.31	-1.15	-1.02	-0.92	-0.84	-0.77	-0.71	-0.66
	60	-3.85	-2.98	-2.40	-2.00	-1.70	-1.48	-1.31	-1.17	-1.06	-0.97	-0.89	-0.82	-0.77
	80	-4.16	-3.24	-2.63	-2.20	-1.89	-1.65	-1.46	-1.31	-1.19	-1.09	-1.00	-0.93	-0.87
	100	-4.45	-3.50	-2.86	-2.40	-2.07	-1.81	-1.61	-1.44	-1.31	-1.20	-1.11	-1.03	-0.96
	120	-4.73	-3.74	-3.07	-2.59	-2.23	-1.96	-1.74	-1.57	-1.42	-1.31	-1.20	-1.12	-1.05
	135	-4.93	-3.92	-3.23	-2.73	-2.36	-2.07	-1.84	-1.66	-1.51	-1.38	-1.28	-1.19	-1.11

If safe loading shown above is not satisfactory to your requirements, it is possible to adjust performance by using alternative fastener layouts, purlin specifications and/or deflection limits. For further information please contact the Technical Department T: +44 (0) 1244 892199.

# Performance benefits



## Thermal performance

Trisomet® complies with the minimum requirements of the conservation of fuel and power sections of the Building Regulations for England and Wales (Part L2) and Scotland (Technical Handbook Section 6 Energy). The panel construction offers highly consistent insulation performance, and the site-formed junctions provide a practical and effective method of ensuring good thermal performance.

Thickness (mm)	U-value (W/m <sup>2</sup> K)*	Typical application
40	0.46	Unheated building
60	0.33	Min Part L requirement for wall
80	0.25	Min Part L requirement for roof
100	0.20	Enhanced
120	0.16	Enhanced
135	0.15	Enhanced

\* Figures computer modelled in accordance with EN ISO 10211 as stated in MCRMA Technical Note 14.



## Fire safety

Trisomet® carries Grade EXT-B and EXT-A approval by the LPCB. Also Fire resistance performance of 4 hours integrity and 22 mins insulation are achievable with 40 mm and 60 mm core panels and 30 mins insulation for panels 80 mm and above. These are attained using standard fixing and sealing methods (external side-lap stitched at maximum 300 mm centres). The panel achieves a Grade AA rating in accordance with BS 476-3, which tests for external surface spread of flame and fire penetration (AA is the best result achievable). The internal surface of the panel complies with Class 'O' in accordance with the Building Regulations when tested to BS 476 Parts 6 & 7 and also achieves a Class B s2 rating in accordance with EN 13501-1.



## Acoustic performance

The acoustic performance of Trisomet® has been predicted using software developed by the Department of Applied Acoustics, University of Salford, under a research contract funded by the Metal Cladding and Roofing Manufacturers Association (MCRMA). The results in the table are based on an 80 mm core.

Frequency (Hz)	SRI Values (dB)*	Frequency (Hz)	SRI Values (dB)*
100	12.1	800	27.2
125	13.6	1,000	28.9
160	15.3	1,250	30.6
200	16.9	1,600	32.5
250	18.5	2,000	34.3
315	20.2	2,500	36
400	21.9	3,150	35.9
500	23.6	4,000	33.8
630	25.4	5,000	31.2

Weighted S,R,I RW = 28.5 dB

\* The predicted sound reduction index values should only be used to provide guidance for preliminary design and/or appraisal of cladding systems.



## Water penetration

In accordance with product standard BS EN 14509, the water-tightness of a system should be tested to EN 12865. The standard advises that the system should achieve water-tightness to a pressure of 600 Pa for normal conditions. Laboratory testing shows evidence that the Trisomet® system is water-tight up to a pressure of 1200 Pa, which far surpasses this requirement.



## Air-tightness

The cladding panel and its junction details must be air-tight so that the air permeability of the building does not exceed 10m<sup>3</sup>/h/m<sup>2</sup> at an applied pressure of 50 Pa, in accordance with the Building Regulations for England and Wales (Part L2) and Scotland (Technical Handbook Section 6 Energy). In laboratory tests in accordance with EN BS 12114, the sealed panel show evidence of air leakage as low as 0.43 m<sup>3</sup>/h/m<sup>2</sup>.

A practical expectation for a finished building, with effective sealing at all junctions would be 3-5 m<sup>3</sup>/h/m<sup>2</sup>. However enhanced detailing practises on large shed buildings can realise air leakage performance figures of less than 3 m<sup>3</sup>/h/m<sup>2</sup>.



## Environmental credentials

Trisomet® is a sustainable solution with responsible sourcing and traceability of all component materials. All steel elements are produced within the Tata Steel's UK steel production, strip processing, galvanising, coating and profiling facilities. In addition the system's carbon footprint is further minimised by the manufacturing process being situated adjacent to Colorcoat® pre-finished steel production facility.

The PIR insulation within the system has zero ozone depletion potential (ODP) and a very low global warming potential (GWP) of less than 5. Both these factors support the achievement of a high BREEAM rating.

All steel elements are 100 % recyclable back into new steel products, without loss of quality. The insulation can be separated using existing scrap shredding technology, after which the materials can be recovered or recycled.



# Summary of Building Regulations requirements for the conservation of fuel and power



## Introduction to changes

The latest amendment to the England AD-L2 and Wales Part L Regulations for the conservation of fuel and power (2013) came into effect on 6 April and 31 July 2014 respectively. The revision to Section 6 Scotland is scheduled for 2015.

AD-L2 follows the principle of the 2010 Regulations but with significant changes in the definition of the types of buildings that make up the aggregate mix. As before, the whole building is assessed using the SBEM 'whole building methodology' that expresses the energy performance. Since it is the building services that emit CO<sub>2</sub> and not the building elements, the total energy building performance takes account of the CO<sub>2</sub> emission resulting from the provision of heating, hot water, ventilation, cooling and lighting. It is therefore based on the building's use in occupation.

In Part L 2010, two notional buildings were defined for top-lit (warehouses) and side-lit (all other) buildings. In Part L 2013 notional buildings reflect the different energy profiles and building services plant likely to be found in the buildings and are defined for:

- Toplit (warehouses – further defined by size)
- Sidelit (heated only)
- Sidelit (heated and cooled)

For 2013, the aggregate approach to CO<sub>2</sub> reductions introduced for the 2010 revision have been retained. This means that the CO<sub>2</sub> emissions across the predicted building mix will be 9% lower than the same building mix constructed to 2010 standards.

The total building stock emissions are based on a set of standard building types and occupancy profiles which are defined in the national calculation methodology (NCM)

The actual improvement of a building constructed to 2013 requirements may be more or less than 9%.

There is no correlation for individual buildings. The 9% improvement is an aggregated average across the stock which would be achieved if all buildings were constructed to the notional building specification.

The notional building specification is used to calculate the CO<sub>2</sub> emission target for a building. The designer does not have to use the notional building specification for the actual building but must ensure that the actual building emission rate is ≤ the target emission rate.

For Wales the improvement factor is 20% reduction. The specification for the notational building to achieve this is the same as for England but includes a 5.3% Gross Internal Area (GIA) of PV. Welsh regulations have also introduced a Target Primary Energy Consumption (TPEC) set by the notional building.

In order to achieve the 9% target improvement in energy/carbon emissions for 2013, the set values in the notional building have been further improved compared to 2010, including:

- Lower air permeability rate.
- Improvements to lighting and controls.
- Improved efficiency of services and controls.
- Limitations on the effect of solar gain.

However fabric U-values have been retained at 2010 levels.

## Envelope U-values

The U-values used in the 2013 notional (non-domestic) buildings together with the backstop values are the same as the 2010 levels with the exception of window U-values, see Table 1. There is no differentiation between heated only and heated and cooled buildings in the notional building.

## Air Permeability

In AD-L2:2013 for non-domestic buildings air permeability is the only part of the fabric performance that has been improved beyond the 2010 levels. The major change is that air permeability levels are defined according to 'Gross Internal Area' (GIA) becoming lower as the GIA increases. Following the research shown below and representation from EPIC and MCRMA the levels for smaller top-lit buildings (below 250 m<sup>2</sup>) have been relaxed to 7 m<sup>3</sup>/m<sup>2</sup>/h.

Table 2 illustrates the changes which are shown in m<sup>3</sup>/(h.m<sup>2</sup>) at 50 Pa according to GIA. There is a backstop level of 10 m<sup>3</sup>/(h.m<sup>2</sup>) at 50 Pa. The 10 m<sup>3</sup>/(h.m<sup>2</sup>) limit is a mandatory requirement for all new buildings except those below 500 m<sup>2</sup> for which 15 m<sup>3</sup>/(h.m<sup>2</sup>) can be adopted without testing.

In Scotland, air permeability is expressed as a 'recommended limit' of 10 m<sup>3</sup>/(h.m<sup>2</sup>) - the same value as that used in SBEM for Scotland. Testing became mandatory for warrants made after 1 May 2011.

**Table 1**

### Fabric U-values and backstop levels

AD-L2A England & Wales	2013 notional building values			2013 Backstop values
	Sidelit/unlit (spec. is heating only)	Sidelit/unlit (spec. includes cooling)	Toplit	
Roofs	0.18 W/m <sup>2</sup> K	0.18 W/m <sup>2</sup> K	0.18 W/m <sup>2</sup> K	0.25 W/m <sup>2</sup> K
Walls	0.26 W/m <sup>2</sup> K	0.26 W/m <sup>2</sup> K	0.26 W/m <sup>2</sup> K	0.35 W/m <sup>2</sup> K
Floors	0.22 W/m <sup>2</sup> K	0.22 W/m <sup>2</sup> K	0.22 W/m <sup>2</sup> K	0.25 W/m <sup>2</sup> K
Glazing	1.6 W/m <sup>2</sup> K	1.6 W/m <sup>2</sup> K	N/A	2.2 W/m <sup>2</sup> K
Rooflight	N/A	N/A	1.8 W/m <sup>2</sup> K	2.2 W/m <sup>2</sup> K
Rooflight (max. area)	N/A	N/A	12 % area	N/A
Renewable energy (Wales only)	5.3	5.3	5.3	5.3
TPEC (Wales only)				
Section 6 Scotland <sup>(1)</sup>	Requirements			Max. area weighted values <sup>(3)</sup>
Roofs (Scotland)	Pitched - 0.16 W/m <sup>2</sup> K – Flat <sup>(2)</sup> - 0.25 W/m <sup>2</sup> K <sup>(2)</sup>			0.20 W/m <sup>2</sup> K
Walls (Scotland)	0.30 W/m <sup>2</sup> K			0.27 W/m <sup>2</sup> K

(1) Values for Scotland are the 2010 levels, due for revision in 2015.

(2) 'Flat' is defined as 'flat roofs with integral insulation' and includes insulated panels.

(3) Maximum area weighted values for all elements of the same type (see clause 6.2.1).

**Table 2**

### Air permeability levels by Gross Internal Area (GIA)

2013 notional building values	Side lit/unlit	Side lit/unlit	Toplit
	(heating only)	(inc. cooling)	
GIA ≤ 250 m <sup>2</sup>	5 m <sup>3</sup> /(h.m <sup>2</sup> )	5 m <sup>3</sup> /(h.m <sup>2</sup> )	7 m <sup>3</sup> /(h.m <sup>2</sup> )
250 m <sup>2</sup> < GIA ≤ 3500 m <sup>2</sup>	3 m <sup>3</sup> /(h.m <sup>2</sup> )	3 m <sup>3</sup> /(h.m <sup>2</sup> )	7 m <sup>3</sup> /(h.m <sup>2</sup> )
3500 m <sup>2</sup> < GIA ≤ 10000 m <sup>2</sup>	3 m <sup>3</sup> /(h.m <sup>2</sup> )	3 m <sup>3</sup> /(h.m <sup>2</sup> )	5 m <sup>3</sup> /(h.m <sup>2</sup> )
10000 m <sup>2</sup> < GIA	3 m <sup>3</sup> /(h.m <sup>2</sup> )	3 m <sup>3</sup> /(h.m <sup>2</sup> )	3 m <sup>3</sup> /m <sup>2</sup> /h

# Roof applications

## Model specification

### H43 Insulated panel cladding/covering

#### 120 Insulated steel faced roof panel:

##### Tata Steel, LPCB approved Trisomet®.

Cladding systems in England and Wales to be designed and installed to meet the Building Regulations 2000, Approved Document L2 2013.

Cladding systems in Scotland to be designed and installed to meet the Building Standards (Scotland) Regulations **Technical Handbook**: Section 6 Energy.

- **Support structure:** Steel purlins.
- **Bearing width (minimum):** 60 mm end lap extension plates maybe required where three or more panels comprise the total roof slope.
- **Pitch:** 4 degree minimum.
- **Manufacturer:** Tata Steel, Shotton, Deeside, Flintshire, CH5 2NH. Technical Department  
T: +44 (0) 1244 892199.
- **Product reference:** Trisomet®.
- **Fire:** LPS1181 Grade EXT-B Certificate No. 460a/30. Internal lining Class O as tested to with BS 476 parts 6 and 7. Class B s2 in accordance with EN 13501-1. External face Class AA in accordance with BS 476-4.
- **Fragility:** Class B in accordance with ACR (M) 001:2005.

- **British Board of Agrément (BBA):** Colorcoat® to BBA Certificate No. 91/2717.
- **External facing material:** Colorcoat HPS200 Ultra® pre-finished steel using Galvalloy® metallic coating, 0.5 mm nominal thickness, based on a zinc (95 %): aluminium (5 %) eutectic alloy that conforms to EN 10346:2009.
- **External profile:** 32 mm high trapezoidal profile with a 333 mm pitch.
- **Colour:** See Colorcoat HPS200 Ultra® range of colours.
- **Internal facing material:** Colorcoat® High Reflect or Colorcoat® PE 15 pre-finished steel using hot-dip galvanised steel EN 10346:2009 substrate.
- **Internal profile:** Lightly planked.
- **Core insulation:** PIR closed cell foam (CFC and HCFC free, zero ODP and GWP <5) to specification used in LPCB approval.
- **Cover width:** 1000 mm.
- **Panel thickness:** 40, 60, 80, 100, 120 or 135 mm.
- **Primary fasteners:** Austenitic stainless steel self-drilling fasteners with thread free zone and 19 mm sealing washers from:  
EJOT UK Limited,  
T: +44 (0) 1977 687040 or  
SFS intec Ltd,  
T: +44 (0) 113 208 5500.
- **Fastener location:** Fix-through profile trough.
- **Number and location of fasteners:** At all support positions, locate in the centre of every trough (ie, three fasteners per support).
- **End-lap size (minimum):** 150 mm.
- **End-laps:** Tail stitch at crown positions, 50 mm from the end of lap.
- **Side laps to be stitched at 450 mm centres:** Austenitic stainless steel self-drilling fasteners with 14 mm sealing washers from:  
EJOT UK Limited,  
T: +44 (0) 1977 687040 or  
SFS intec Ltd,  
T: +44 (0) 113 208 5500.
- **U-value:** 0.46 W/m<sup>2</sup>K for 40 mm panel; 0.33 W/m<sup>2</sup>K for 60 mm panel; 0.25 W/m<sup>2</sup>K for 80 mm panel; 0.20 W/m<sup>2</sup>K for 100 mm panel; 0.16 W/m<sup>2</sup>K for 120 mm panel or 0.15W/m<sup>2</sup>K for 135 mm panel.



## General requirements

### 170 Design

Roof cladding to be designed to comply with design and installation guidance in the Tata Steel literature.

### 172 Thermal bridging:

To reduce thermal bridging follow the construction details found in the Tata Steel literature.

### 300 Profile fillers:

- **Material:** EPDM.
- **Colour:** Black.
- **Thickness:** 25 mm.
- **Fixing:** Compression fix between sheets and flashings/supports. Seal into place as top and bottom with gun grade butyl mastic.

### 480 Flashing and trim details

- **System type:** Use Tata Steel construction details to reduce thermal bridging.
- **Material and finish:** To match outer sheet, 0.7 mm minimum gauge.
- **Manufacturer:** Tata Steel, T: +44 (0) 1244 892199.
- **Lap joint treatment:** End joints to be lapped by 150 mm and sealed, unless specified otherwise. Where possible, arrange with laps away from the prevailing wind. Where butt joints are required, butt joint and seal flashings and/or trims on 150 mm wide butt straps made from sheet of the same material and finish.
- **Method of fixing:** Fix to cladding with sealed rivets or integral nylon colour-headed austenitic stainless steel self-drilling fasteners at 450 mm minimum centres, supplied by: EJOT UK Limited, T: +44 (0) 1977 687040 or

SFS intec Ltd,  
T: +44 (0) 113 208 5500.

- **Design:** Maximum unstiffened leg on flashing to be 200 mm. Visible free edges to be finished with a stiffened edge or welt.
- 550 **Sealing laps on external sheets**
  - **Sealant tape:** 6 x 5 mm high grade butyl mastic (25 year guarantee) supplied by:  
Premier Sealants (White strip), T: +44 (0) 1724 864100  
EJOT UK Limited (Blue Strip), T: +44 (0) 1977 687040  
SFS intec Ltd, (Pink Strip), T: +44 (0) 113 208 5500.
  - **Position:** Position sealant in straight, unbroken lines across the profile. Place into troughs. Do not allow to stretch or to sag into position.
  - **Seal quality:** Ensure continuity and effectiveness of seal, especially at corner of sheets.
  - **End-lap sealant-tape positions:** Two lines of butyl mastic (25 year guarantee) should be placed between sheets before fixing rows 10 mm from the sheet ends at the top and bottom of the lap.
  - **Side laps:** A continuous run of butyl mastic (25 year guarantee) on top of the under lap crown positioned to the weather side of stitching fastener.
- 554 **Air sealing**  
The panel edges at ridge, eaves and verge must be seated onto a 6 mm diameter bead of high grade butyl mastic (25 year guarantee) supplied by:  
Premier Sealants (White strip), T: +44 (0) 1724 864100  
EJOT UK Limited (Blue Strip).

T: +44 (0) 1977 687040  
SFS intec Ltd, (Pink Strip),  
T: +44 (0) 113 208 5500.

The metal lining layer must be reasonably air-tight so that the air permeability does not exceed 10 m<sup>3</sup>/h/m<sup>2</sup> at an applied pressure of 50 Pa in accordance with the Building Regulations 2000, Approved Document L2 2013. Under laboratory testing sealed liner sheets show evidence of air leakage as low as 0.46 m<sup>3</sup>/h/m<sup>2</sup>. A reasonable practical expectation for a finished system would be 3 to 5 m<sup>3</sup>/h/m<sup>2</sup>. A reasonable practical expectation for a finished system would be 3 to 5 m<sup>3</sup>/h/m<sup>2</sup>. Ensure internal flashings are fully sealed to ensure continuity and effectiveness of seal, especially at corners of sheets such as at roof/wall junctions and at all penetrations of pipes, ducts, etc.

### Platinum Plus® system guarantee

A Platinum® system guarantee specification needs to be registered prior to tender package being distributed.

Obtaining a 25 year Platinum Plus® guarantee could not be simpler; simply request the guarantee from Tata Steel.

Tata Steel acts as the one point of contact from beginning to end. We will provide you with a detailed NBS specification, warranties for all specified elements and full support for the duration of the guarantee period.

### Technical Department

For further information or to register your Platinum Plus® system guarantee specification please telephone the Technical Department  
T: +44 (0) 1244 892199.



# Construction details – roof

The details within this section are recommendations and have been designed to give practical solutions to minimise thermal bridging and air loss at junctions. For each junction detail,  $\Psi$  values (Psi) and f values have been calculated in accordance with BS EN ISO 10211 and recommendations within MCRMA technical paper 18.

NB. All support steelwork by others.

## Side lap

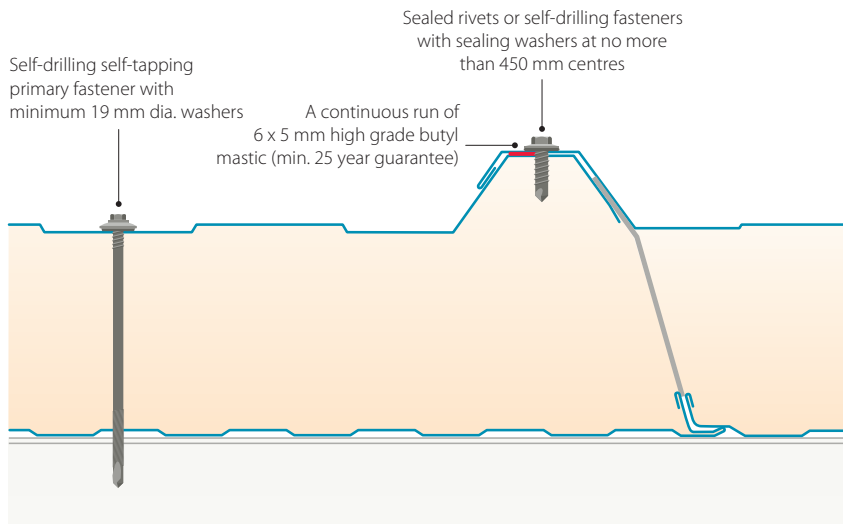

## Side lap

The side lap joint design enables panels to be dropped-in place when side lapping, this provides fast and efficient installation.

## End lap

End lap stitchers to be positioned as shown at each crown position to ensure compression of seals over the rib positions.

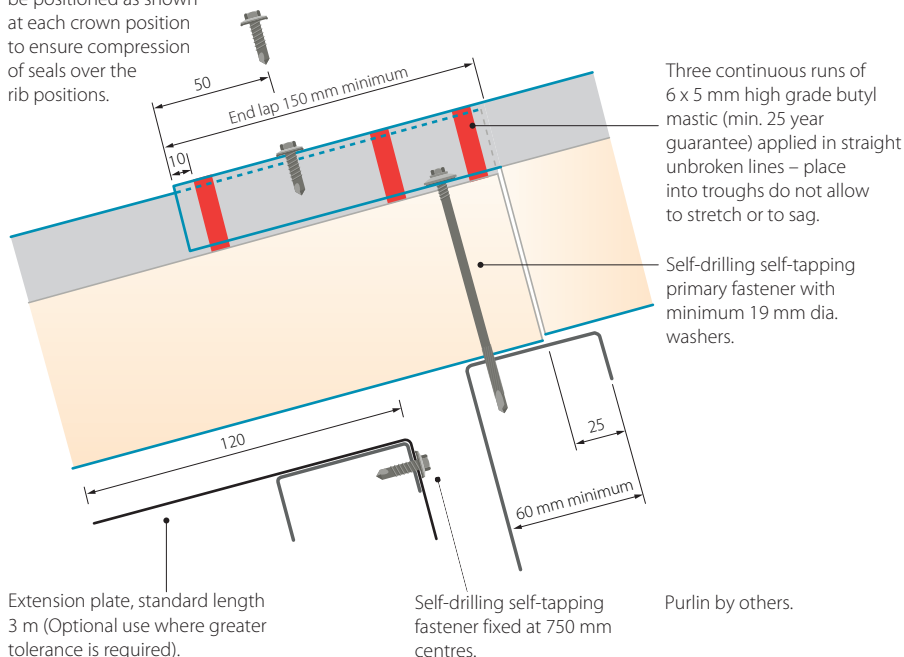

## End lap

Three primary fasteners should be used at the end lap. Fasteners are positioned in the centre of each trough. Tail stitchers should be used at every crown 50 mm from the end of the lap. Care must be taken to ensure the correct land on the purlin so that both panels edges are supported and the fastener is able to be positioned through both panels as shown.

## Ridge

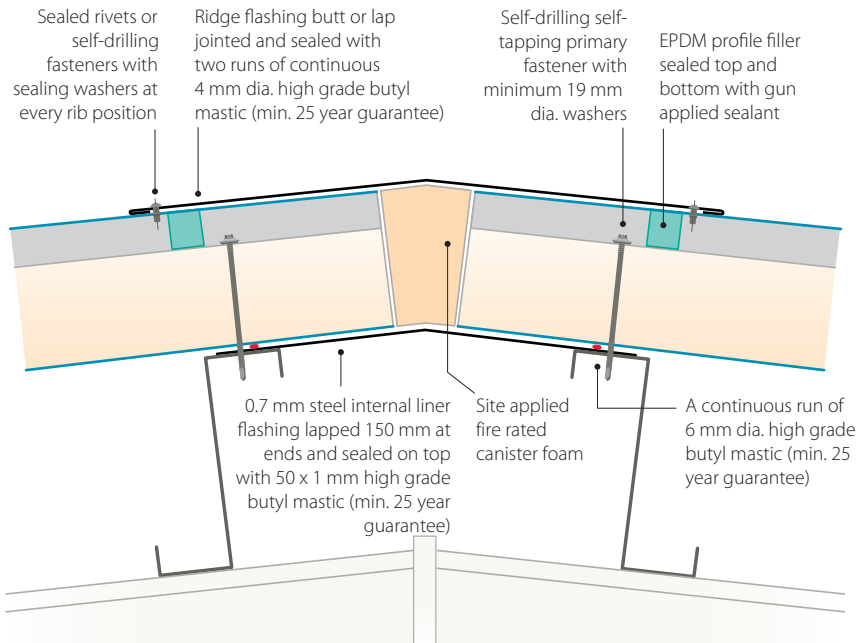

## Ridge

Fillers should be positioned back from the edge of the ridge flashing by approximately 80 mm to avoid the risk of bird attack.

Psi value (W/mK)	f factor
0.009	0.975

Stated calculation results are dependant on components being as shown. Computer modelled in accordance with EN ISO 10211.

## Eaves

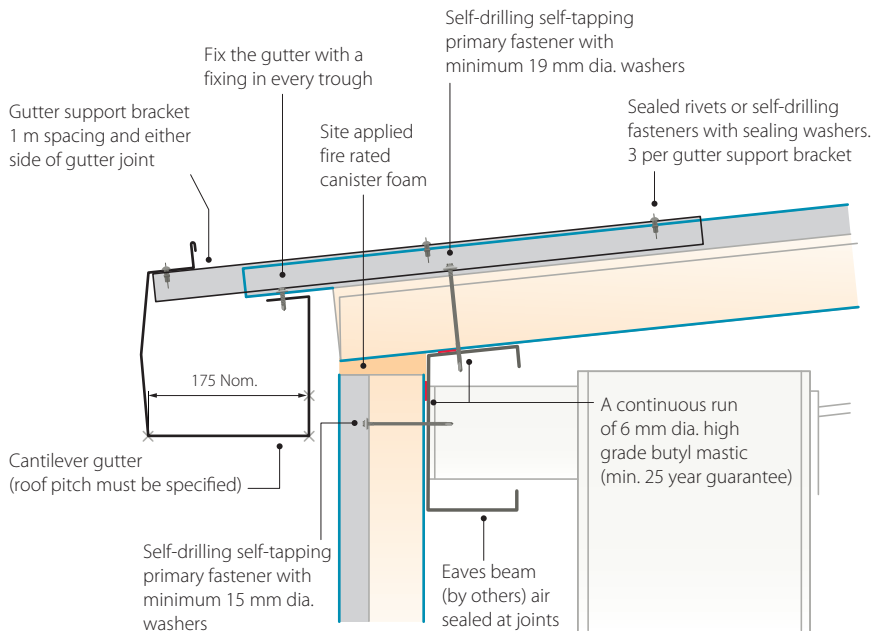

## Eaves

The Cantilever Gutter System is manufactured to suit the pitch of the roof and downpipes can be positioned as required.

For further information on the Cantilever Gutter System and assistance with rainflow calculations please contact the Technical Department:  
T: +44 (0) 1244 892199.

Psi value (W/mK)	f factor
0.222	0.903

Stated calculation results are dependant on components being as shown. Computer modelled in accordance with EN ISO 10211.

# Construction details – roof continued

## Parapet

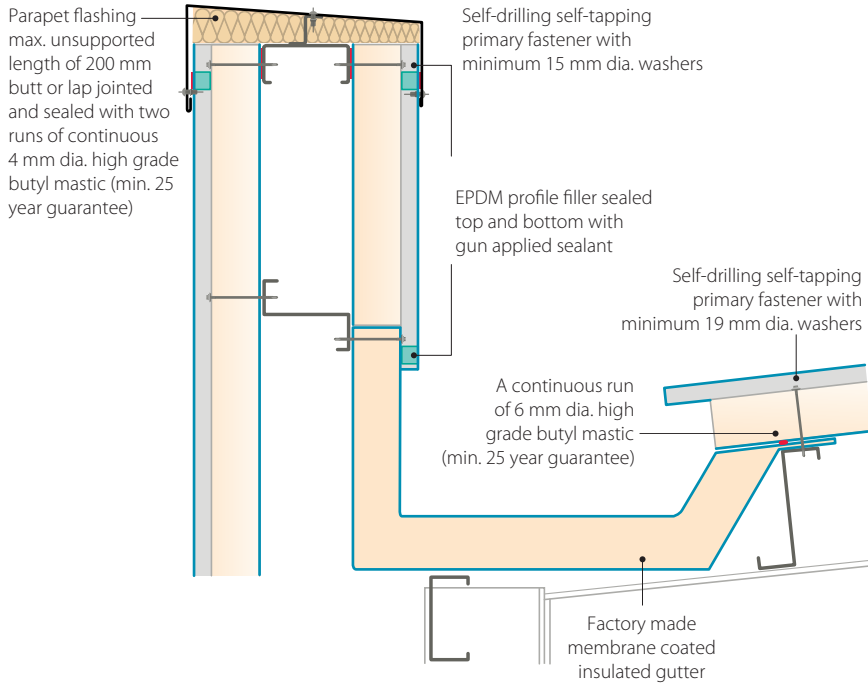

### Parapet

The parapet height should be a minimum of 950 mm from roof level to be considered as sufficient edge protection as recommended by the HSE.

Psi value (W/mK)	f factor
1.365	0.615

Stated calculation results are dependant on components being as shown. Computer modelled in accordance with EN ISO 10211.

## Verge start

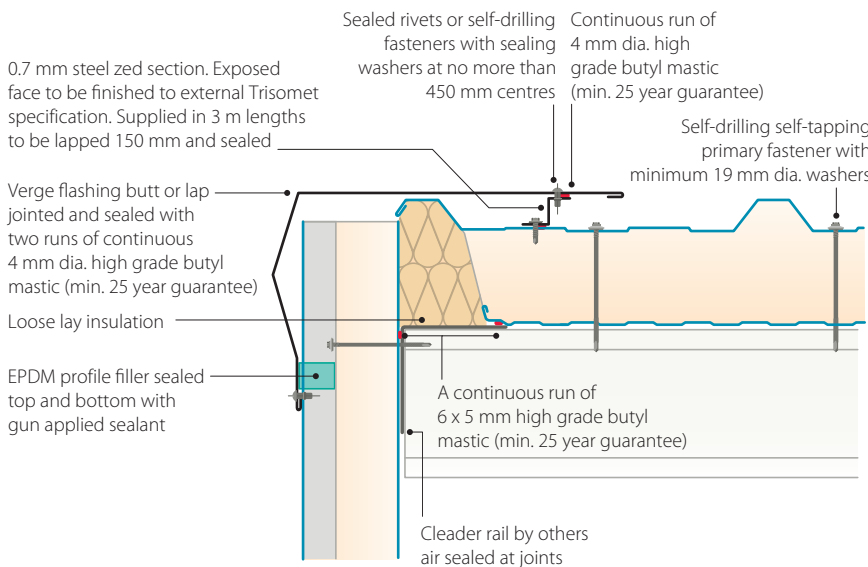

### Verge start

The Z section used to support the Verge Flashing is made from the same Colorcoat® material as the external face of the panel, so that it matches the durability performance of the roof.

Psi value (W/mK)	f factor
0.062	0.948

Stated calculation results are dependant on components being as shown. Computer modelled in accordance with EN ISO 10211.



**Verge end**

0.7 mm steel zed section matching external Trisomet® skin supplied in 3 m lengths to be lapped 150 mm and sealed

Self-drilling self-tapping primary fastener with minimum 19 mm dia. washers

Verge flashing butt or lap jointed and sealed with two runs of continuous 4 mm dia. high grade butyl mastic (min. 25 year guarantee)

Site applied fire rated canister foam

Sealed rivets or self-drilling fasteners with sealing washers at no more than 450 mm centres

Continuous run of 4 mm dia. high grade butyl mastic (min. 25 year guarantee)

A continuous run of 6 mm dia. high grade butyl mastic (min. 25 year guarantee)

Cleader rail by others air sealed at joints

EPDM profile filler sealed top and bottom with gun applied sealant

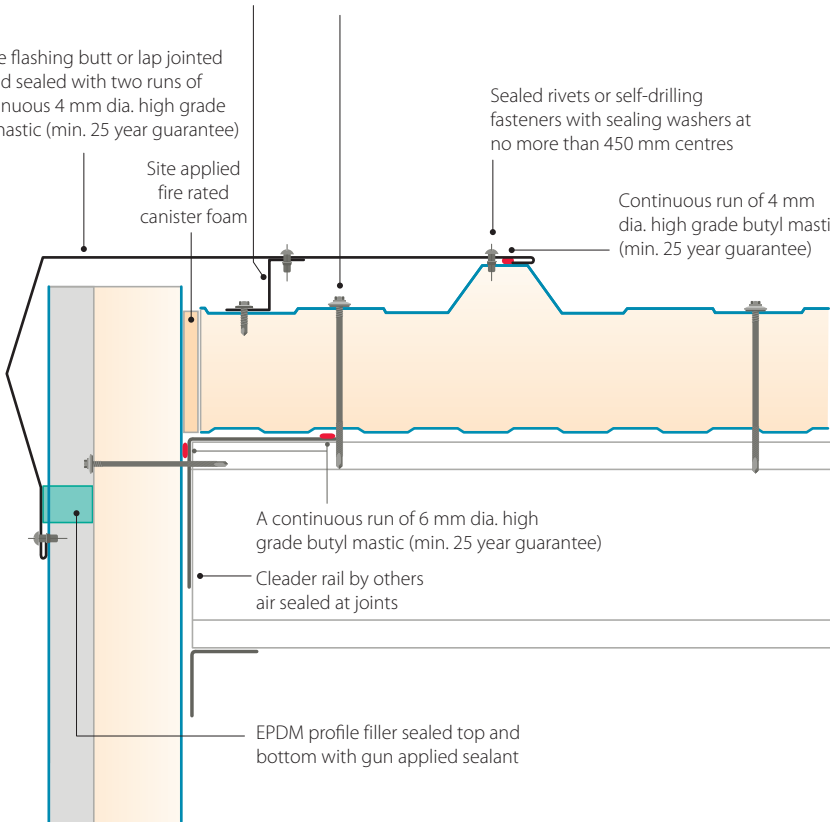

200 max.

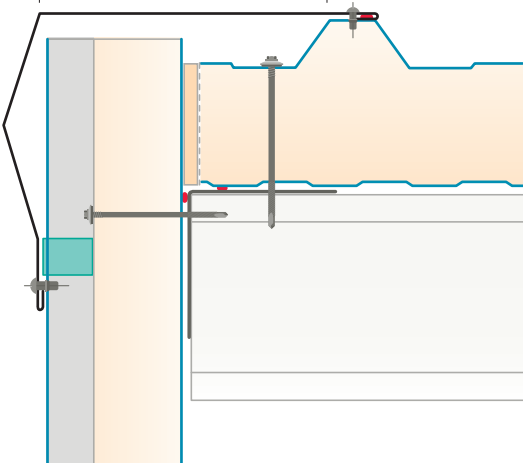

**Verge end**

It is recommended that single skin flashing have a maximum unsupported leg length of 200 mm to maintain the strength for a flat appearance.

Psi value (W/mK)	f factor
0.098	0.948

Stated calculation results are dependant on components being as shown. Computer modelled in accordance with EN ISO 10211.

# Construction details – roof continued

## Valley gutter

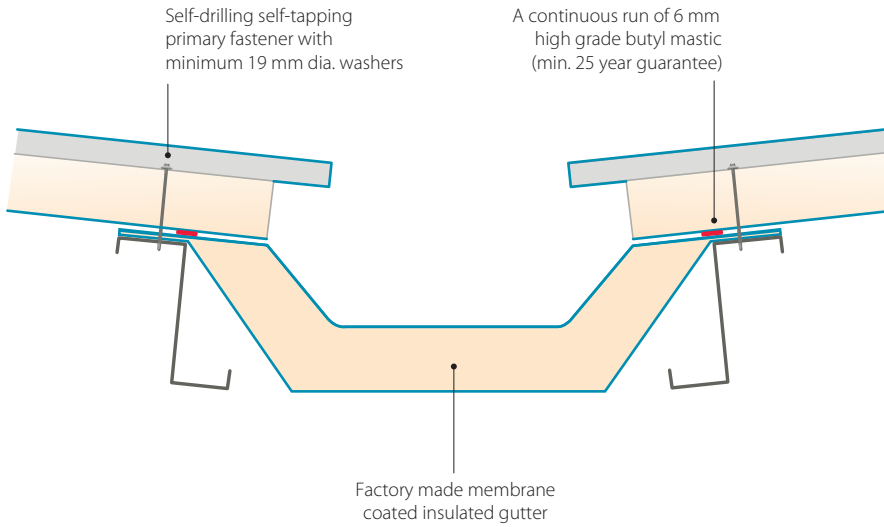

### Valley gutter

Ensure a full design is carried out in accordance with BS EN 12056-3:2000 and all manufactures recommendations are followed to ensure correct detailing at this important junction.

Psi value (W/mK)	f factor
0.736	0.559

Stated calculation results are dependant on components being as shown. Computer modelled in accordance with EN ISO 10211.

## Valley hip

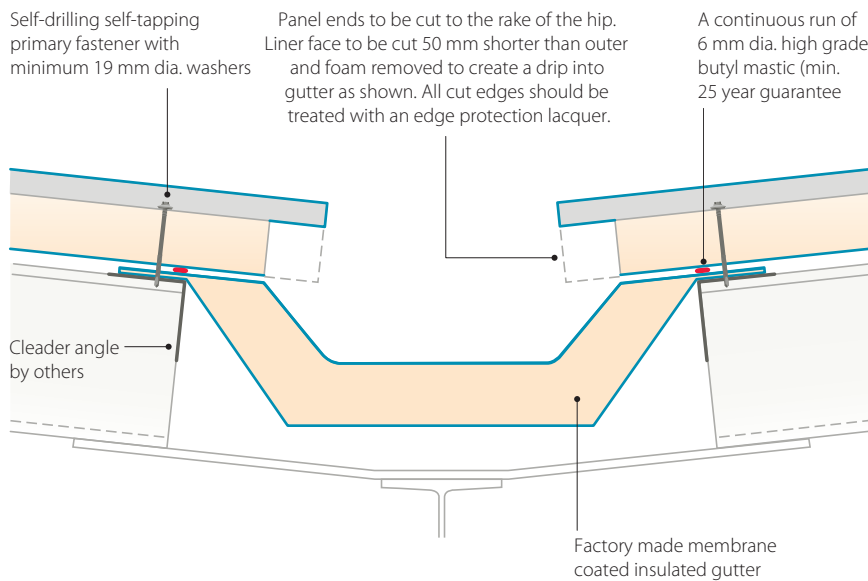

### Valley hip

The cut back to the panel end is created to avoid water running down the face of the panel and generating the risk of tracking into the panel side lap.

Psi value (W/mK)	f factor
0.736	0.559

Stated calculation results are dependant on components being as shown. Computer modelled in accordance with EN ISO 10211.

**Standard pipe seal (Dektite)**

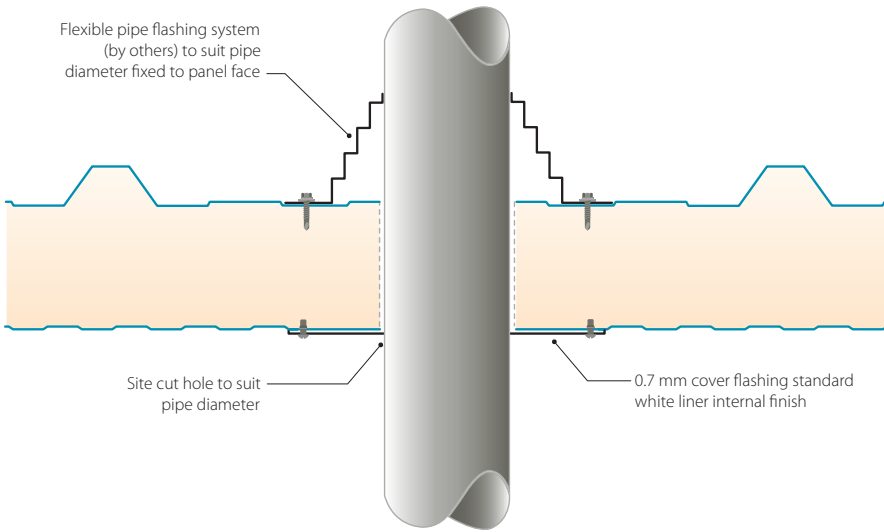

**Standard pipe seal and hot pipe seal (Dektite)**

The pipe flashings are available in various specifications to facilitate different opening sizes and temperature ranges. Further details on these specifications and for order placement please contact our Platinum Plus® system guarantee approved suppliers, who are:

SFS intec Ltd, T: +44 (0) 113 208 5500  
or EJOT UK, T: +44 (0) 1977 687040.

**Hot pipe seal (Dektite)**

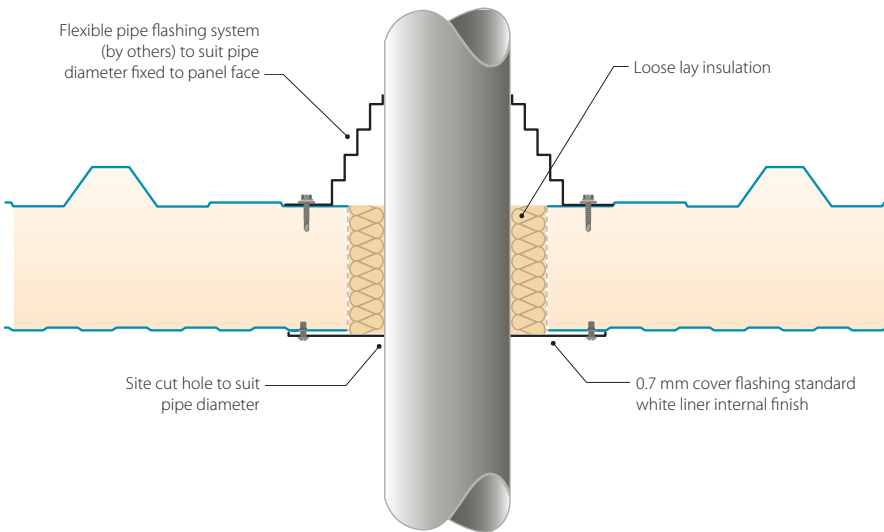

# Construction details – roof continued

## Velux roof light

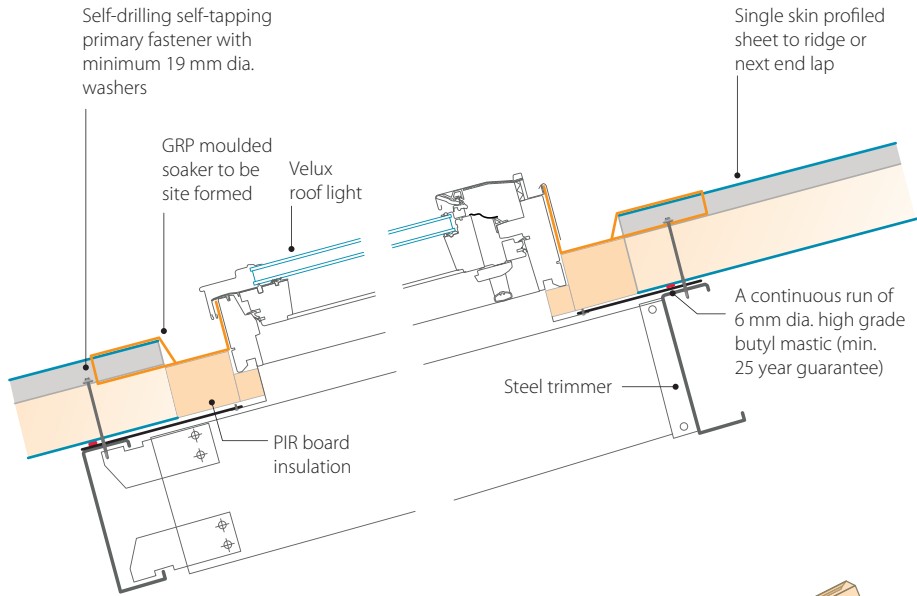

**Velux roof light**  
The detail shown indicates a Velux system. These systems will require specialist advice for installation and maintenance. Therefore Tata Steel recommend that this specialist advice be obtained from Velux, details below.

Velux  
T: +44 (0) 1592 778 297  
E: velux-gb@velux.com  
www.velux.com

**Recommended companies for GRP moulding**  
M R Site Services  
Unit 6, Worcester Trading Estate  
Blackpole, Worcester  
Worcestershire, WR3 8HR  
T: +44 (0) 1905 755055  
F: +44 (0) 1905 755053

Jones and Woolman  
Unit 6, Hayes Trading Estate  
Hingley Road, Halesowen  
West Midlands, B63 2RR  
T: +44 (0) 1922 712111  
F: +44 (0) 1922 712539

**Note:** correct, width, length and upstand lip should be specified

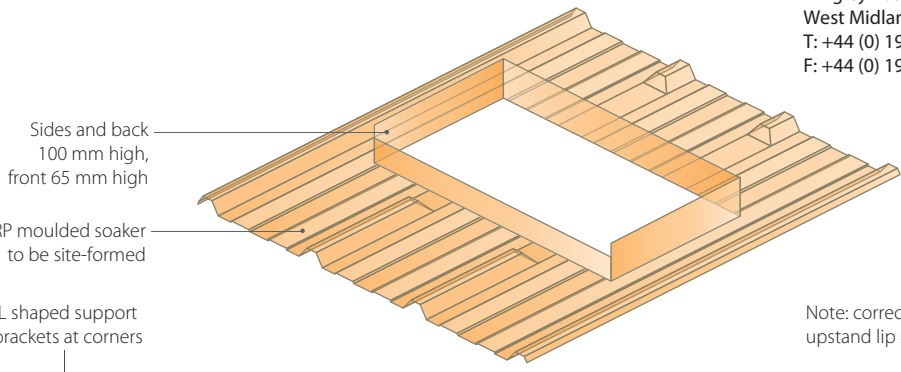

Note: correct width, length and upstand lip should be specified

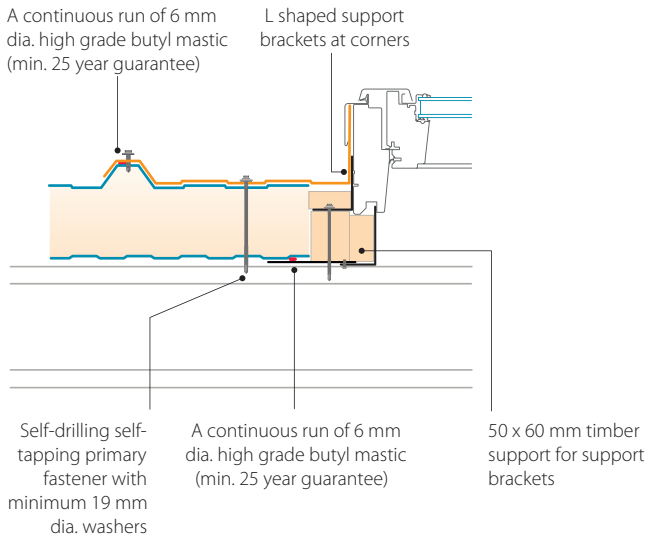

### Roof light side lap

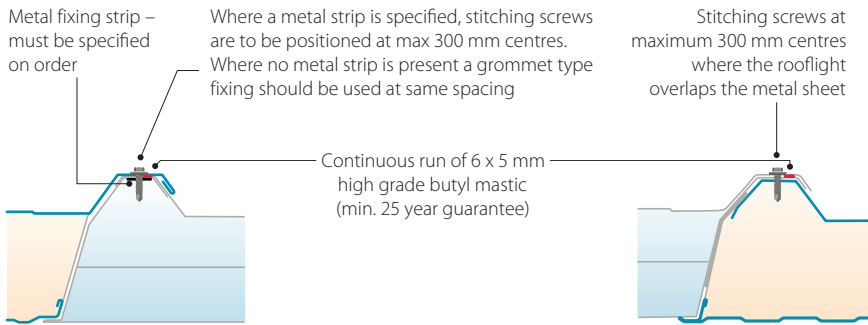

In order to achieve a 2.2 W/m<sup>2</sup>K. U-value and comply with the current building regulations for heated buildings a minimum of a triple skin roof light construction should be specified. The central core can be adapted to provide the level of insulation required. U-values as low as 1.0 W/m<sup>2</sup>K can be achieved.

### Fixing arrangement at all support positions

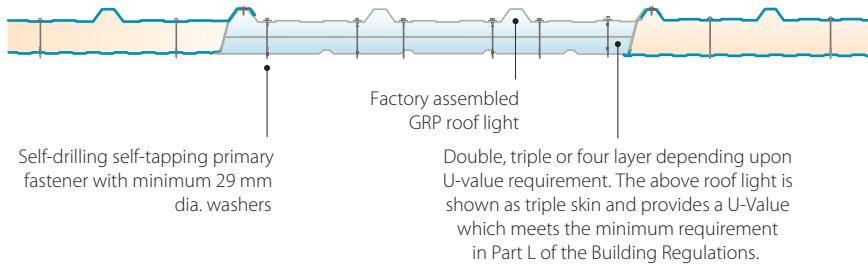

**Note:** it is not recommended to lap roof lights in series as this may cause misalignment due to varying tolerance between the panel and roof light units.

### Roof light end lap

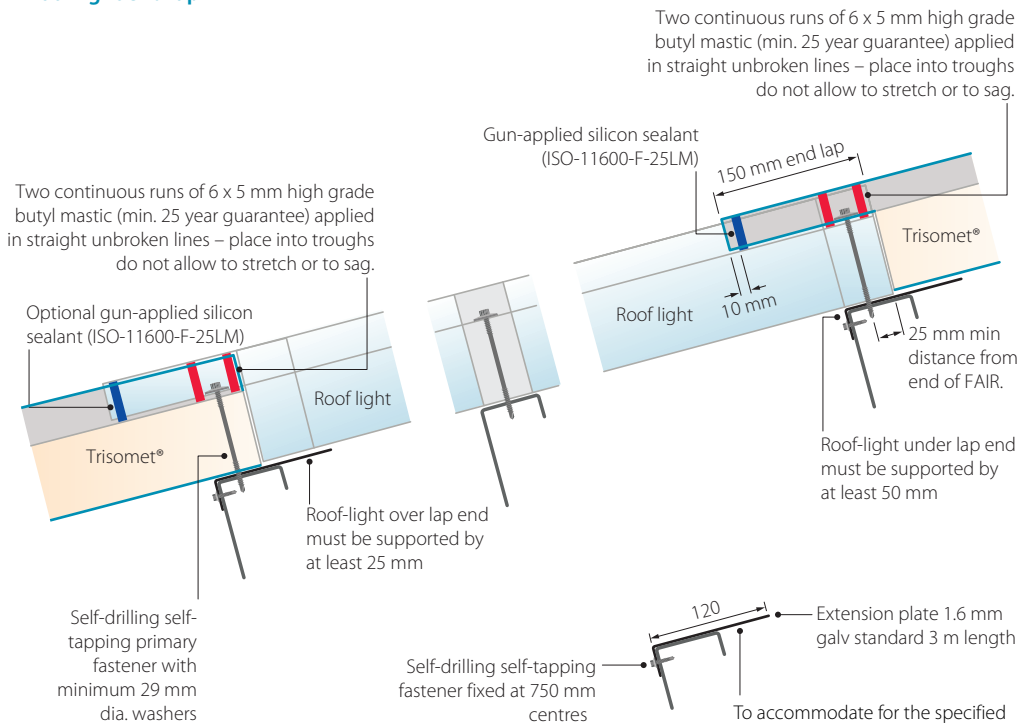

**Roof light end lap**  
When ordering roof lights accurate purlin positions must be provided so fillers can be correctly positioned within the roof light construction.

All support steel work by others

To accommodate for the specified purlin land and/or tolerance of steel work on sit, an extension plate can be used to ensure adequate land dimensions are achieved. This plate can also be used to obscure the sight of the filler blocks from inside the building.

# Construction details – roof continued

## Large pipe seal

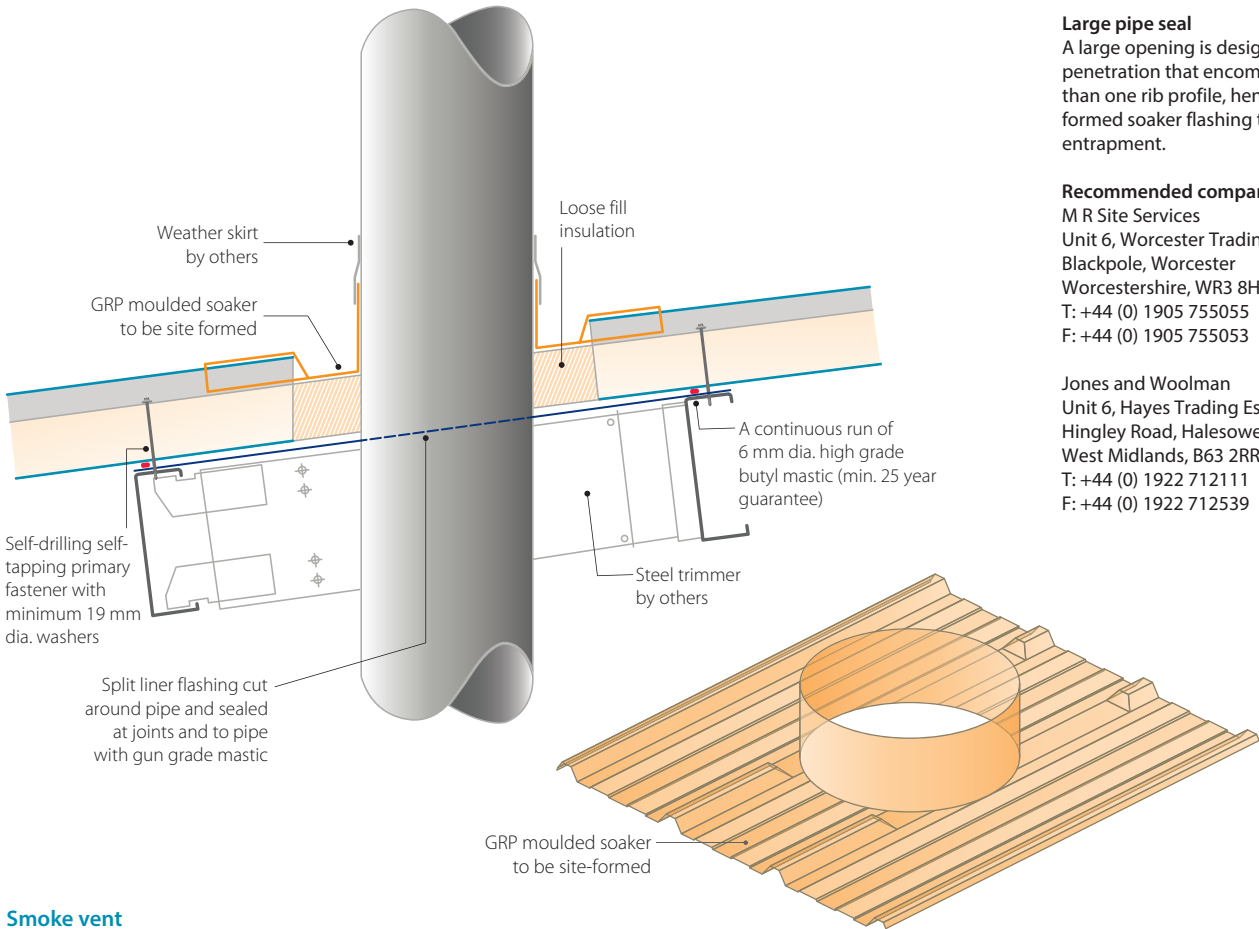

### Large pipe seal

A large opening is designated by a penetration that encompasses more than one rib profile, hence requiring a formed soaker flashing to avoid water entrapment.

### Recommended companies for GRP moulding

M R Site Services  
Unit 6, Worcester Trading Estate  
Blackpole, Worcester  
Worcestershire, WR3 8HR  
T: +44 (0) 1905 755055  
F: +44 (0) 1905 755053

Jones and Woolman  
Unit 6, Hayes Trading Estate  
Hingley Road, Halesowen  
West Midlands, B63 2RR  
T: +44 (0) 1922 712111  
F: +44 (0) 1922 712539

## Smoke vent

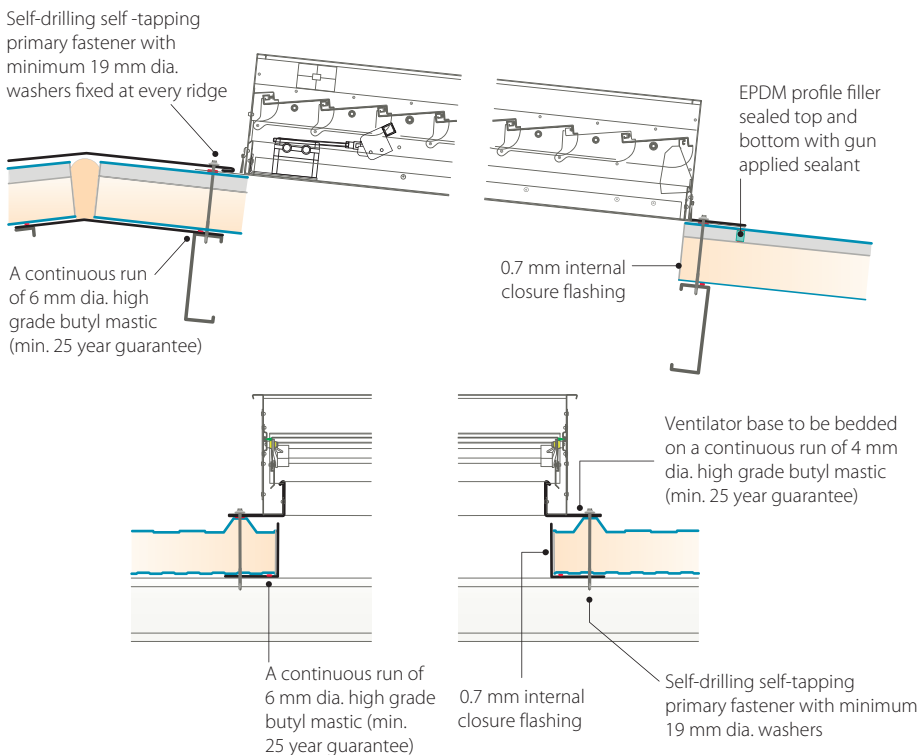

### Smoke vent

The detail shown indicates a Colt International system. These systems will require specialist advice for installation and maintenance. Therefore Tata Steel recommend that this specialist advice be obtained from Colt, details below.

Colt International Ltd  
T: +44 (0) 2392 451111  
E: info@coltgroup.com  
www.coltinfo.co.uk

All support steelwork by others

### Expansion joint

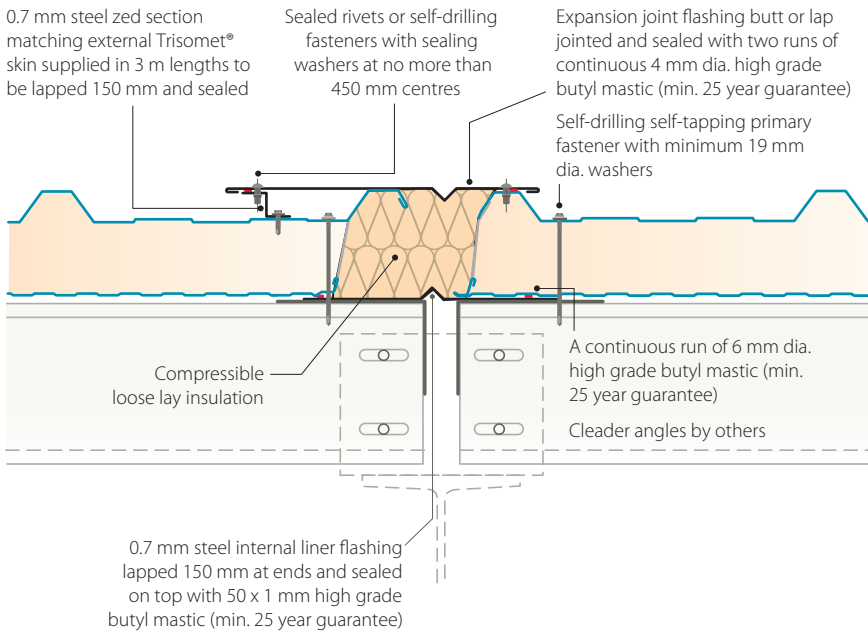

**Expansion joint**  
The 'V' formed flashing allows movement at this junction.

Psi value (W/mK)	f factor
0.024	0.972

Stated calculation results are dependant on components being as shown. Computer modelled in accordance with EN ISO 10211.

### Roof to wall junction

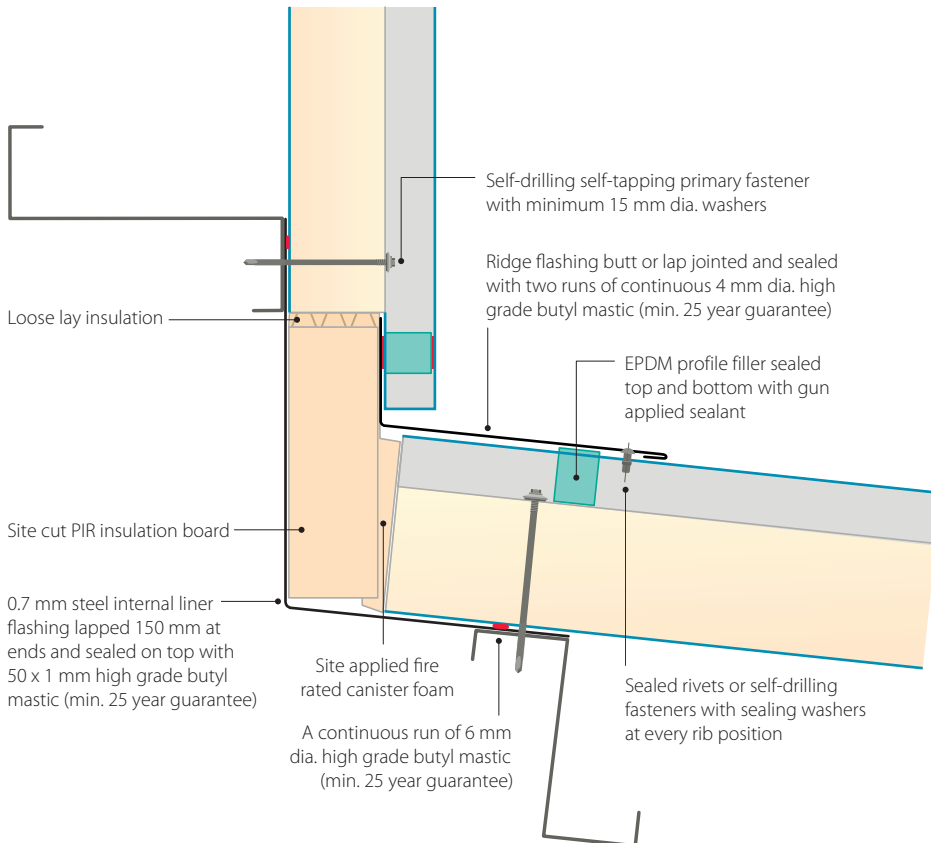

**Roof to wall junction**  
The PIR board is used to provide a comparative level of thermal performance around the junction. The thickness of this board should be selected to match the core thickness of the wall panel. The loose lay insulation is used to the top of the PIR board to allow tolerance when installing the wall panel.

Psi value (W/mK)	f factor
0.019	0.975

Stated calculation results are dependant on components being as shown. Computer modelled in accordance with EN ISO 10211.

# Construction details – roof continued

## Junction with internal partition with underside of roof

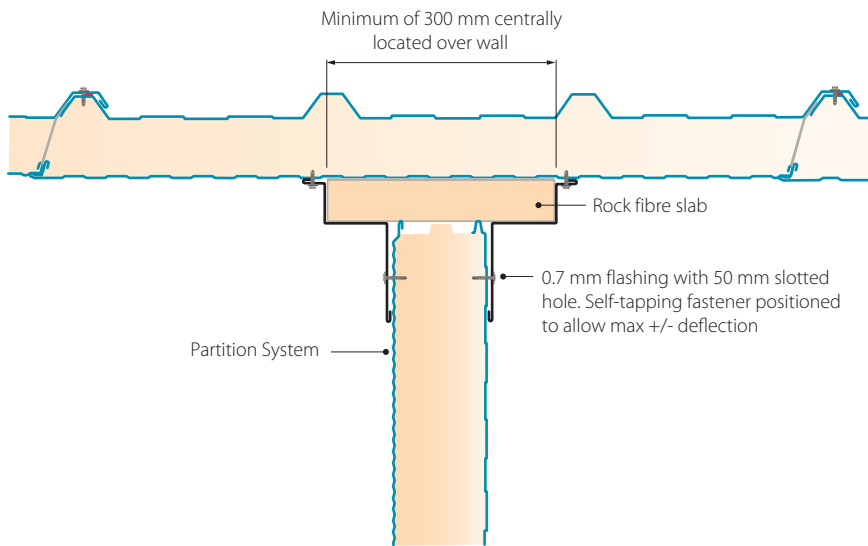

## Junction with internal partition with underside of roof

This detail is supported in Approved Document B of the Building Regulations where the following is quoted in Clause 8.3 of Section 8 'Compartmentation'.

Note: 'Double-skinned insulated roof sheeting with a thermoplastic core should incorporate a band of material of limited combustibility at least 300mm wide centred over the wall'.

## Roof safety system

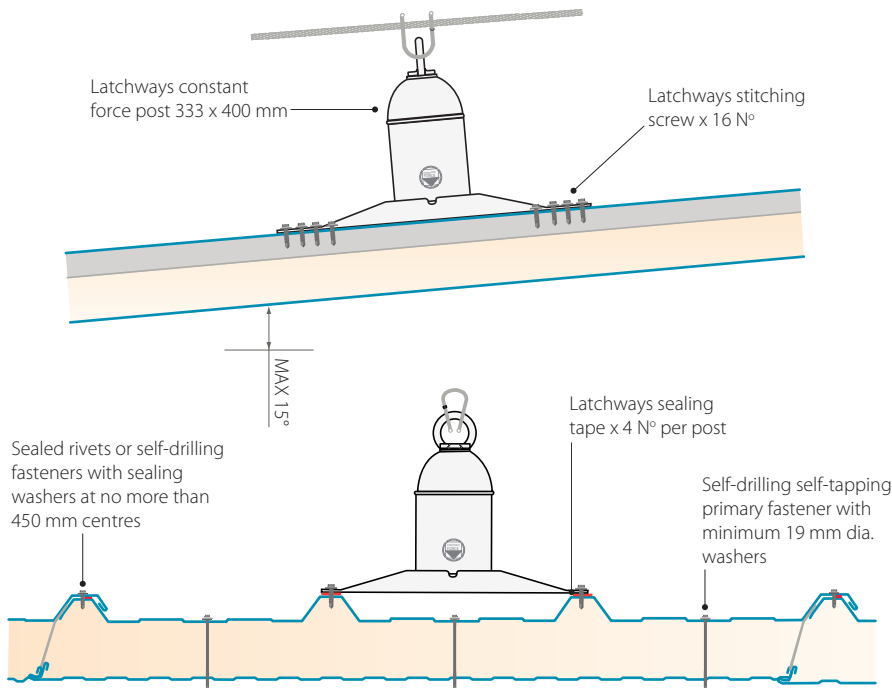

## Roof safety system

The detail shown indicates a Latchways system, however an alternative system is also available from QBM. These systems will require specialist roof layout design and installation, together with a maintenance and inspection programme. Therefore Tata Steel recommend that this specialist advice be obtained from one of two companies below.

Latchways  
T: +44 (0) 1380 732700  
E: hayley.potter@latchways.com  
www.latchways.com

QBM  
T: +44 (0) 1924 440237  
E: technical@qbmdistributors.co.uk  
www.qbmdistributors.co.uk



# Jaffabox Ltd, Bickenhill, Birmingham

The 40,000 sq. ft. multi-million pound factory extension for cardboard box manufacturers Jaffabox Ltd in Bickenhill, Birmingham has enhanced the award winning company's manufacturing capabilities and increased warehousing capacity in order to expand their "just in time" stockholding facilities offered to customers.

The extension features a complete building envelope solution by Tata Steel, installed by Multi-Fab Construction Ltd, who acted as main contractor and were also responsible for structural steelwork on the project.

The building features over 5000 m<sup>2</sup> of Trisomet<sup>®</sup> insulated roof panels and over 1000 m<sup>2</sup> of Trimapanel<sup>®</sup> system architectural wall panels, both in Colorcoat HPS200 Ultra<sup>®</sup> in Goosewing Grey.



Featuring a straightforward side-lapping detail, the Trisomet<sup>®</sup> afforded faster installation and a broad-pan trapezoidal pre-finished steel external profile, providing optimised water drainage, strength and walkability.

Trisomet<sup>®</sup> system's autohesively-bonded polyisocyanurate (PIR) insulation provides exceptional thermal performance from a relatively shallow foam core, enhanced environmental benefits, together with fire performance approved by the Loss Prevention Certification Board (LPCB).

"The client is very pleased with the finished building. Tata Steel were very helpful, delivering products of excellent quality exactly when we needed them."

Commented Steve Tomlinson, Managing Director of Multi-Fab Construction Ltd, reflecting on the project.

Client: Jaffabox Ltd.

Steelwork contractor: Multi-Fab Construction Ltd.

Installation contractor: Multi-Fab Construction Ltd.

System manufacturer: Tata Steel

Cladding systems: Trisomet<sup>®</sup>, Trimapanel<sup>®</sup>

Colorcoat<sup>®</sup> product: Colorcoat HPS200 Ultra<sup>®</sup>



# Wall applications

## Model specification

- 120 Insulated steel faced wall panel:**  
**Tata Steel, LPCB approved Trisomet®.**  
 Cladding systems in England and Wales to be designed and installed to meet the Building Regulations 2000, Approved Document L2 2013.
- Cladding systems in Scotland to be designed and installed to meet the Building Standards (Scotland) Regulations **Technical Handbook:** Section 6 Energy.
- **Support structure:** Cladding rails.
  - **Bearing width (minimum):** 60 mm.
  - **Manufacturer:** Tata Steel, Shotton, Deeside, Flintshire, CH5 2NH. Technical Department  
T: +44 (0) 1244 892199.
  - **Product reference:** Trisomet®.
  - **Fire:** LPS1181 Grade EXT-B Certificate No. 460a/29.  
  
Fire resistance rating of 30 minutes insulation and 4 hours integrity in accordance with BS 476 Part 22 (external stitching screws required at 300mm centres for this classification).  
  
Class O to the Building Regulations. Class B s2 in accordance with EN 13501-1.
  - **British Board of Agrément (BBA):** Colorcoat® to BBA Certificate No. 91/2717.
  - **External facing material:** Colorcoat HPS200 Ultra® or Colorcoat Prisma® pre-finished steel using Galvalloy® metallic coating, 0.5 mm nominal thickness, based on a zinc (95 %): aluminium (5 %) eutectic alloy that conforms to EN 10346:2009.
  - **External profile:** 32 mm high trapezoidal profile with a 333 mm pitch.
  - **Colour:** Colorcoat HPS200 Ultra® or Colorcoat Prisma® range of colours.
  - **Internal facing material:** Colorcoat® High Reflect or Colorcoat® PE 15 pre-finished steel using hot-dip galvanised steel EN 10346:2009 substrate.
  - **Internal profile:** Lightly planked.
  - **Core insulation:** PIR closed cell foam (CFC and HCFC free, zero ODP and GWP < 5) to specification used in LPCB approval.
  - **Cover width:** 1,000 mm.
  - **Panel thickness:** 40, 60, 80, 100, 120 or 135 mm.
  - **Primary fasteners:** Austenitic stainless steel self-drilling fasteners with thread-free zone and 15 mm sealing washers from:  
EJOT UK Limited,  
T: +44 (0) 1977 687040 or  
SFS intec Ltd,  
T: +44 (0) 113 208 5500.
  - **Fastener location:** Fix-through profile trough.
  - **Number and location of fasteners:** At all support positions, locate one fastener in the centre of every trough (ie, three fasteners per support)
  - **End-lap size (minimum):** 100 mm vertical, 50 mm horizontal.
  - **End-laps:** Stitching not required.
  - **Side laps to be stitched at 600 mm centres:** Austenitic stainless steel self-drilling fasteners with 14 mm sealing washers from:  
EJOT UK Limited,  
T: +44 (0) 1977 687040 or  
SFS intec Ltd,  
T: +44 (0) 113 208 5500.
  - **U-value:** 0.46 W/m<sup>2</sup>K for 40 mm panel; 0.33 W/m<sup>2</sup>K for 60 mm panel; 0.25 W/m<sup>2</sup>K for 80 mm panel; 0.20 W/m<sup>2</sup>K for 100 mm panel; 0.16 W/m<sup>2</sup>K for 120 mm panel or 0.15 W/m<sup>2</sup>K for 135 mm panel.
- ### General requirements
- 170 Design**  
 Wall cladding to be designed to comply with design and installation guidance in the Tata Steel literature.
- 172 Thermal bridging:**  
 To reduce thermal bridging follow the construction details found in the Tata Steel literature.
- 300 Profile fillers:**
- **Material:** EPDM.
  - **Colour:** Black.
  - **Thickness:** 25 mm.
  - **Fixing:** Compression fix between sheets and flashings/supports. Seal into place as top and bottom with gun grade butyl mastic.
- 480 Flashing and trim details**
- **System type:** Use Tata Steel construction details to reduce thermal bridging.
  - **Material and finish:** To match outer sheet, 0.7mm minimum gauge.
  - **Manufacturer:** Tata Steel,  
T: +44 (0) 1244 892199.



- **Lap joint treatment:** End joints to be lapped by 150 mm and sealed, unless specified otherwise. Where possible, arrange with laps away from the prevailing wind. Where butt joints are required, butt joint and seal flashings or trims on 150 mm wide butt straps made from sheet of the same material and finish.
- **Method of fixing:** Fix to cladding with sealed rivets or integral nylon colour-headed austenitic stainless steel self-drilling fasteners at 450 mm minimum centres, supplied by: EJOT UK Limited, T: +44 (0) 1977 687040 or SFS intec Ltd, T: +44 (0) 113 208 5500.
- **Design:** Maximum unstiffened leg on flashing to be 200 mm. Visible free edges to be finished with a stiffened edge or welt.

**550 Sealing laps on external sheets when laid vertically**

- **Sealant tape:** 6 x 5 mm high grade butyl mastic (25 year guarantee) supplied by: Premier Sealants (White strip), T: +44 (0) 1724 864100 EJOT UK Limited (Blue Strip), T: +44 (0) 1977 687040 SFS intec Ltd, (Pink Strip), T: +44 (0) 113 208 5500.
- **Position:** Position sealant in straight, unbroken lines across the profile. Place into troughs. Do not allow to stretch or to sag into position.
- **Seal quality:** Ensure continuity and effectiveness of seal, especially at corner of sheets.

- **End-lap sealant-tape positions:** Two lines of butyl mastic (min. 25 year guarantee) should be placed between sheets 10 mm from the sheet ends at the top and bottom of the lap.
  - **Side laps:** A continuous run of 6 x 5 mm diameter high grade butyl mastic (min. 25 year guarantee) on weather side of stitching fastener.
- Sealing laps on external sheets when laid horizontally**
- **Sealant tape:** Gun grade silicon sealant supplied by: Premier Sealants (White strip), T: +44 (0) 1724 864100 EJOT UK Limited (Blue Strip), T: +44 (0) 1977 687040 SFS intec Ltd, (Pink Strip), T: +44 (0) 113 208 5500.
  - **Position:** Position sealant in straight, unbroken lines across the profile. Place into troughs.
  - **Seal quality:** Ensure continuity and effectiveness of seal, especially at corner of sheets.
  - **End lap sealant-tape positions:** Two lines sealant should be placed between sheets 10 mm from the sheet ends at the top and bottom of the lap.
  - **Side laps:** A continuous run of 6 x 5 mm diameter high grade butyl mastic (25 year guarantee) on weather side of stitching fastener.

**554 Air sealing**

The panel edges at base, eaves and corners must be seated onto a 6 mm diameter bead of high grade butyl mastic (25 year guarantee) supplied by:

EJOT UK Limited,  
T: +44 (0) 1977 687040 or  
SFS intec Ltd,  
T: +44 (0) 113 208 5500.

The metal lining layer must be reasonably air-tight so that the air permeability does not exceed 10 m<sup>3</sup>/h/m<sup>2</sup> at an applied pressure of 50 Pa in accordance with the Building Regulations 2000, Approved Document L2 2013. Under laboratory testing sealed panels show evidence of air leakage as low as 0.46 m<sup>3</sup>/h/m<sup>2</sup>.

A reasonable practical expectation for a finished system would be 3 to 5 m<sup>3</sup>/h/m<sup>2</sup>. Ensure internal flashings are fully sealed to ensure continuity and effectiveness of seal, especially at corners of sheets such as at roof/wall junctions and at all penetrations of pipes, ducts, etc.

**Platinum Plus® system guarantee**

A Platinum® system guarantee specification needs to be registered prior to tender package being distributed.

Obtaining a 25 year Platinum Plus® guarantee could not be simpler; simply request the guarantee from Tata Steel.

Tata Steel acts as the one point of contact from beginning to end. We will provide you with a detailed NBS specification, warranties for all specified elements and full support for the duration of the guarantee period.

**Technical Department**

For further information or to register your Platinum Plus® system guarantee specification please telephone the Technical Department T: +44 (0) 1244 892199.



# Construction details – wall

The details within this section are recommendations and have been designed to give practical solutions to minimise thermal bridging and air loss at junctions. For each junction detail,  $\Psi$  values (Psi) and f values have been calculated in accordance with BS EN ISO 10211 and recommendations within MCRMA technical paper 18.

## Vertical details

### Side lap

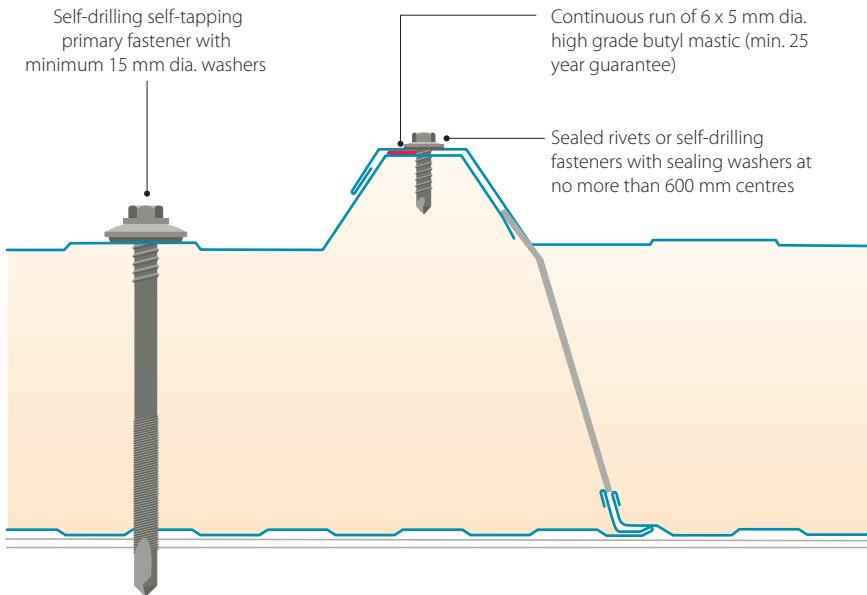

**Side lap**  
The new side lap joint design enables panels to be lapped simply providing fast and efficient installation.

### End lap

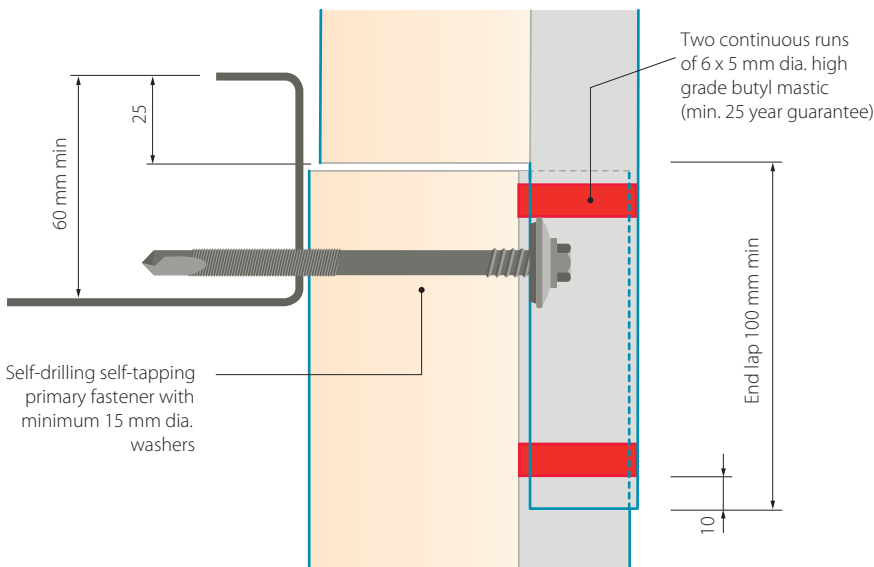

**End lap**  
Three fasteners should be used at the end lap. Fasteners are positioned in the centre of every trough.

### Internal corner

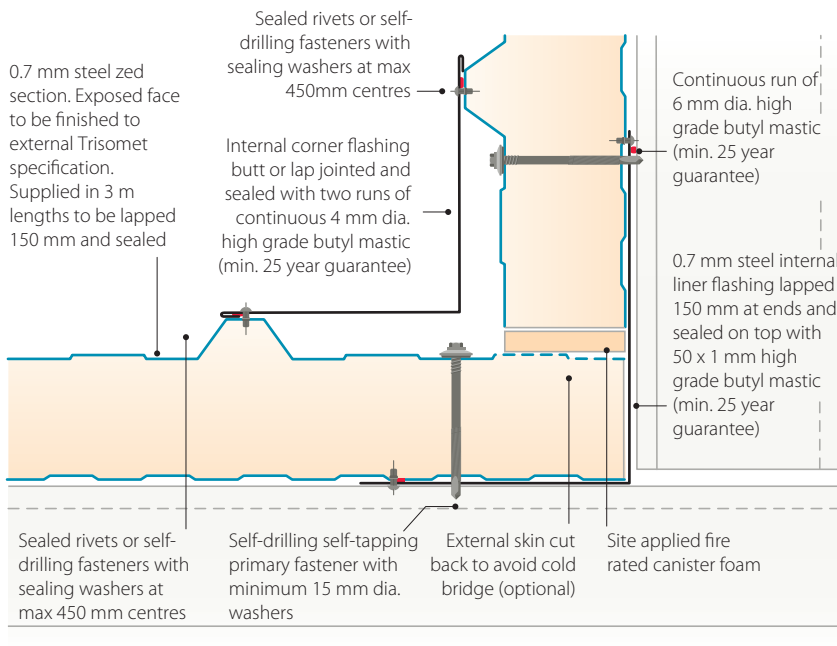

### Internal corner

Thermal performance can be enhanced by the on-site removal of the panel outer skin, within the corner junction, therefore reducing the risk of cold bridging. The outer skin can be easily removed by running a circular saw through the steel approximately 100 mm from the panel edge and then peeling the cut strip away.

Psi value (W/mK)	f factor
With liner cut back	
0.041	0.957
Without liner cut back	
0.092	0.939

Stated calculation results are dependant on components being as shown. Computer modelled in accordance with EN ISO 10211.

### External corner

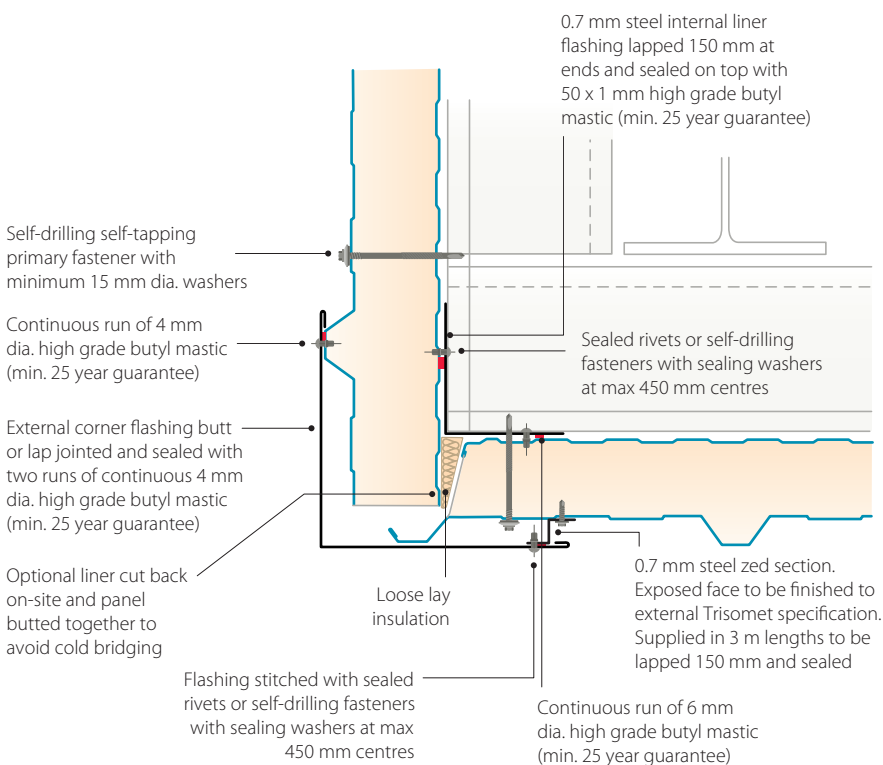

### External corner

Thermal performance can be enhanced by the on-site removal of the panel liner, within the corner junction, therefore reducing the risk of cold bridging. The liner can be easily removed by running a circular saw through the steel approximately 100mm from the panel edge and then peeling the cut strip away.

Psi value (W/mK)	f factor
With liner cut back	
0.019	0.940
Without liner cut back	
0.092	0.939

Stated calculation results are dependant on components being as shown. Computer modelled in accordance with EN ISO 10211.

# Construction details – wall continued

## Drip detail base

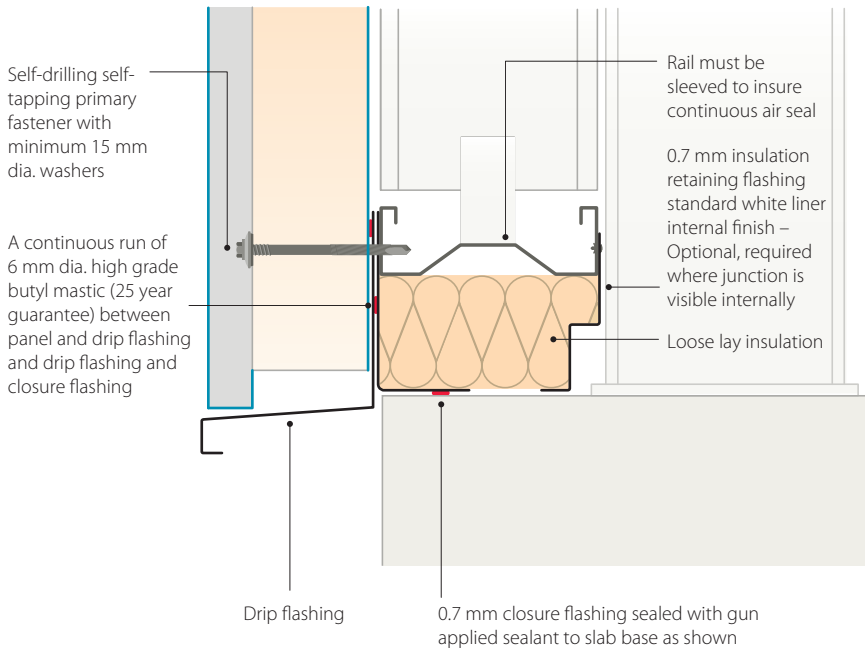

**Drip detail base**  
Loose laid mineral fibre quilt insulation is used below bottom cladding rail to reduce cold bridging at slab base.

Psi value (W/mK)	f factor
0.275	0.687

Stated calculation results are dependant on components being as shown. Computer modelled in accordance with EN ISO 10211.

## Drip detail dado wall

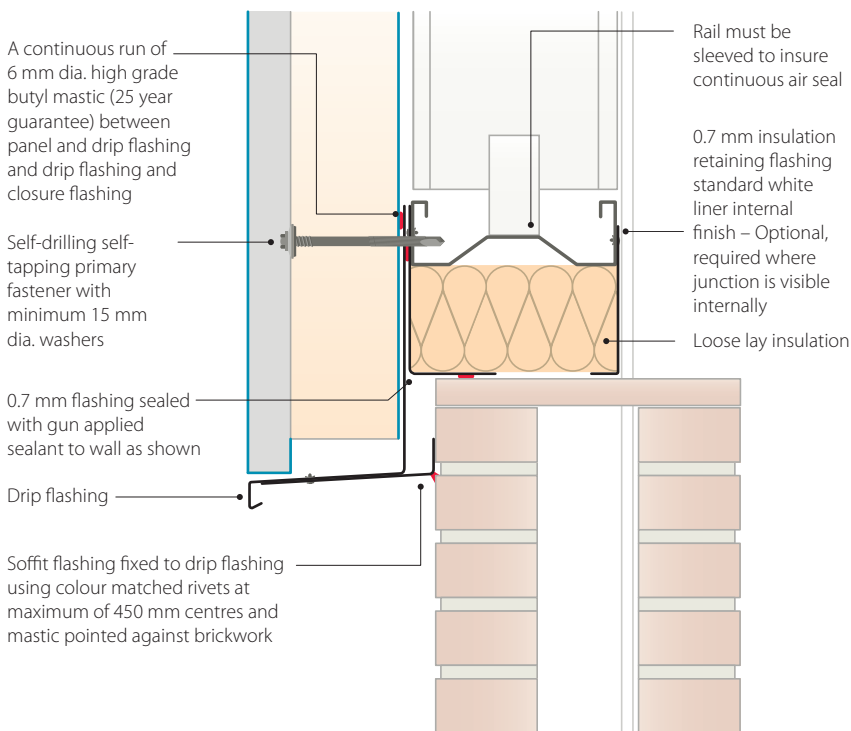

**Drip detail dado wall**  
A 1.6 mm galvanised steel support angle is fixed to the wall, level with the base of the panel, in order to facilitate installation and to ensure the panel is level before fixing.

Psi value (W/mK)	f factor
0.062	0.948

Stated calculation results are dependant on components being as shown. Computer modelled in accordance with EN ISO 10211.

### Window/door head

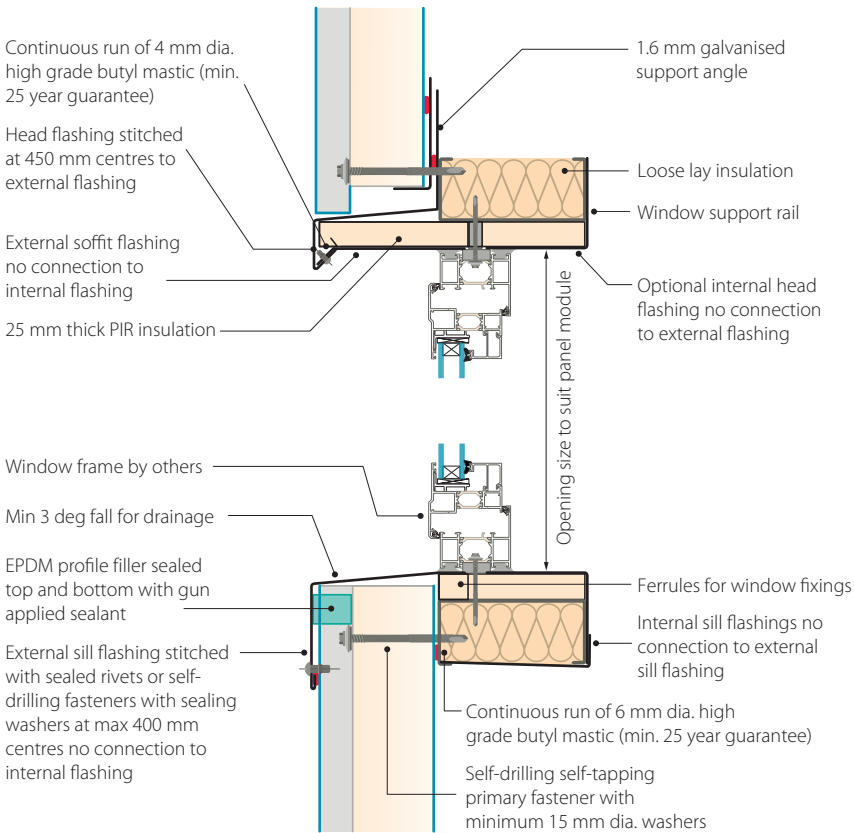

### Window/door head

This window flashing detail has been designed so that it can accommodate any proprietary window.

Psi value (W/mK)	f factor
0.614	0.735

Stated calculation results are dependant on components being as shown. Computer modelled in accordance with EN ISO 10211.

### Window sill

Psi value (W/mK)	f factor
0.613	0.878

Stated calculation results are dependant on components being as shown. Computer modelled in accordance with EN ISO 10211.

### Window/door jamb

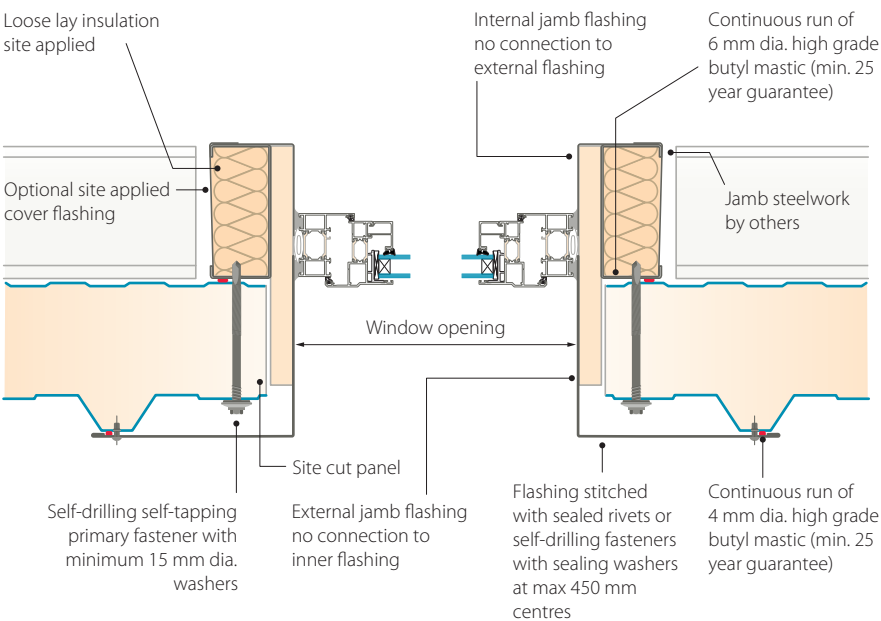

### Window/door jamb

Trimming steel work around the opening is required to support the window or door independent to the panels.

## Construction details – wall continued

### Penetration options, small

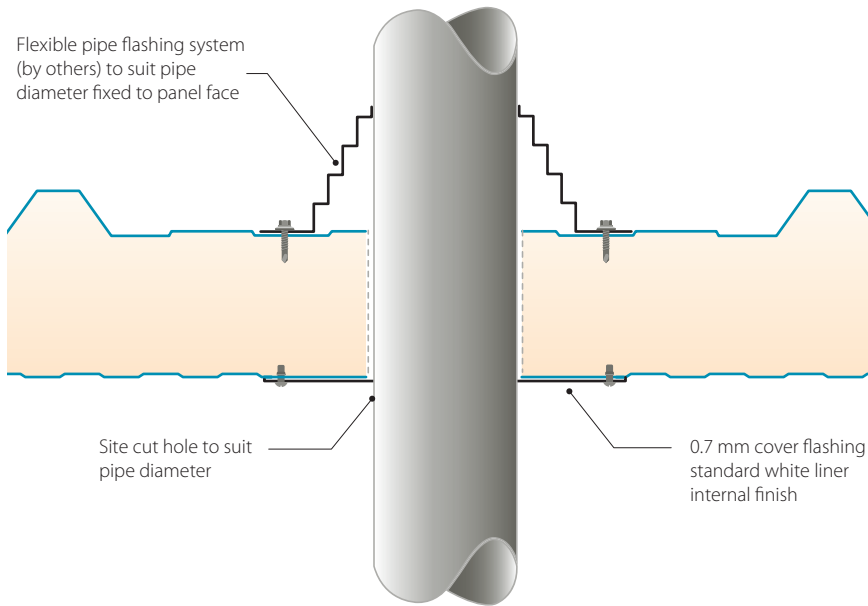

### Penetration options, small and small hot

The pipe flashings are available in various specifications to facilitate different opening sizes and temperature ranges. Further details on these specifications and for order placement please contact our Platinum Plus® system guarantee approved suppliers, who are:

SFS intec Ltd, T: +44 (0) 113 208 5500  
or EJOT UK, T: +44 (0) 1977 687040.

### Penetration options, small hot

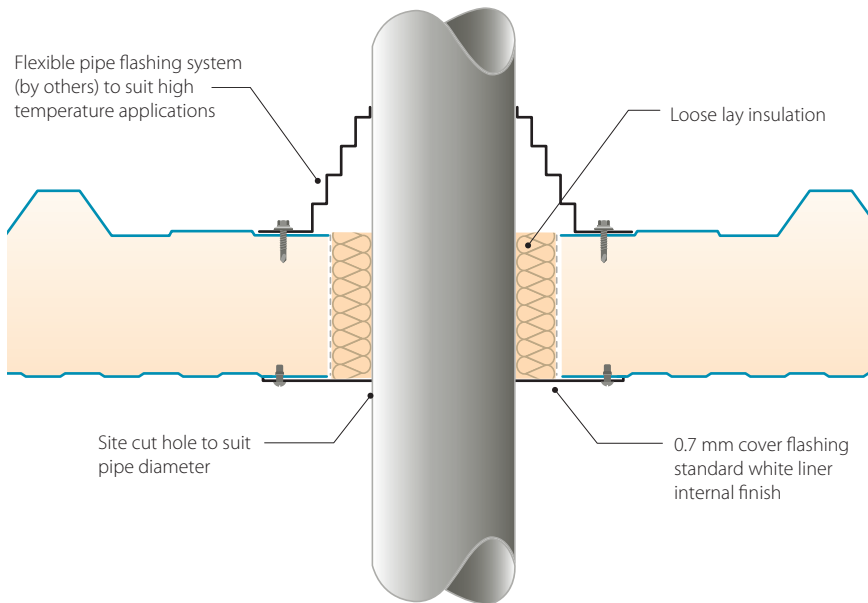



### Vertical to horizontal break

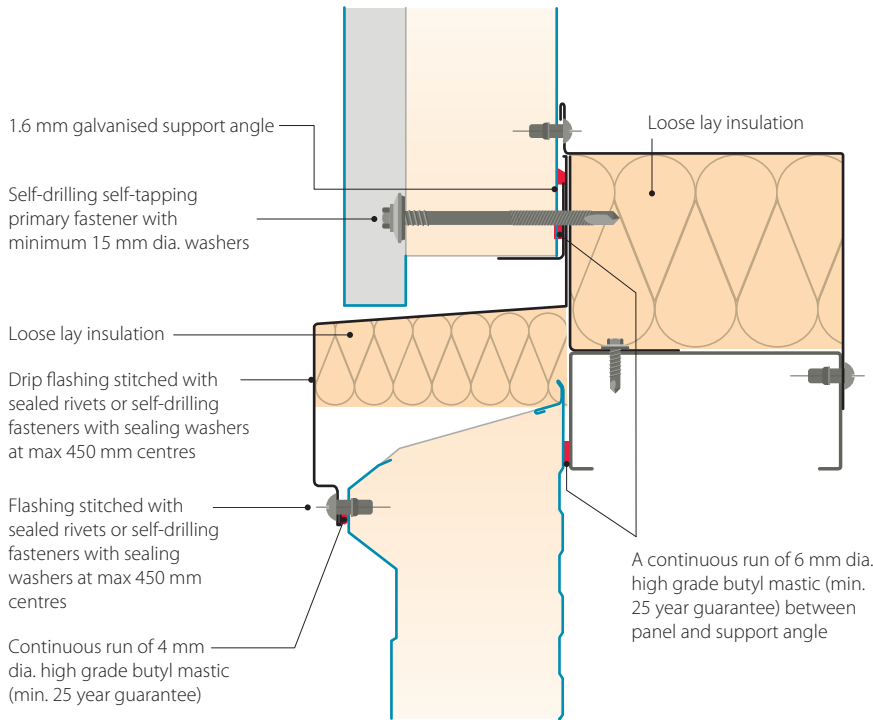

**Vertical to horizontal break**  
Horizontal and vertical panels can be installed adjacent to each other creating interesting architectural features, while the drip flashing detail still maintains thermal performance and an efficient weather seal.

Psi value (W/mK)	f factor
1.103	0.579

Stated calculation results are dependant on components being as shown. Computer modelled in accordance with EN ISO 10211.

### Brick wall abutment

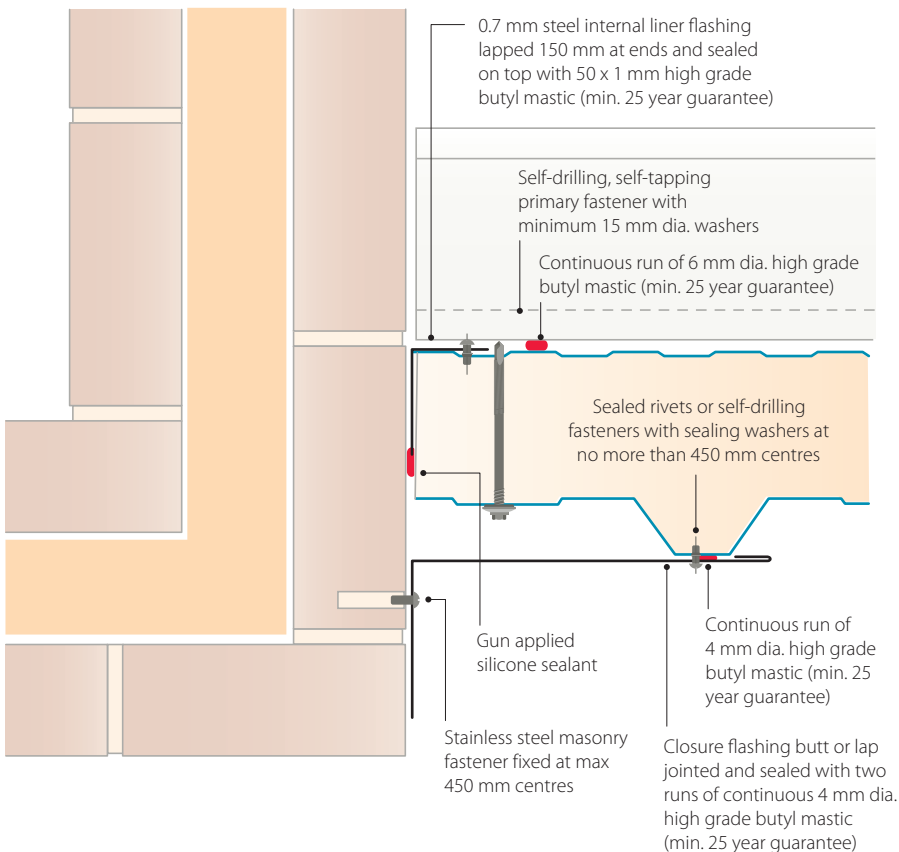

**Brick wall abutment**  
Masonry fasteners to be stainless steel to maintain the durability of the system.

Psi value (W/mK)	f factor
0.260	0.837

Stated calculation results are dependant on components being as shown. Computer modelled in accordance with EN ISO 10211.

# Construction details – wall continued

## Horizontal details

### Side lap

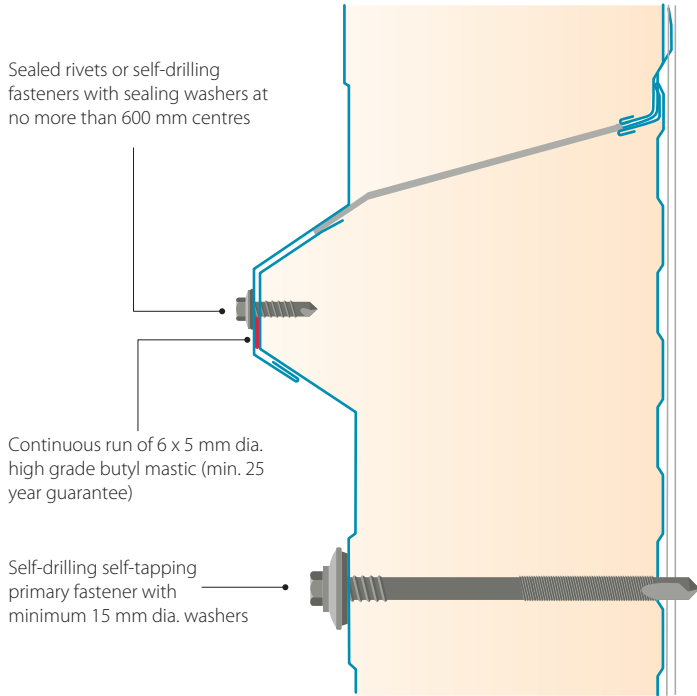

### Side lap

The new side lap joint design enables panels to be lapped simply providing fast and efficient installation.

### End lap

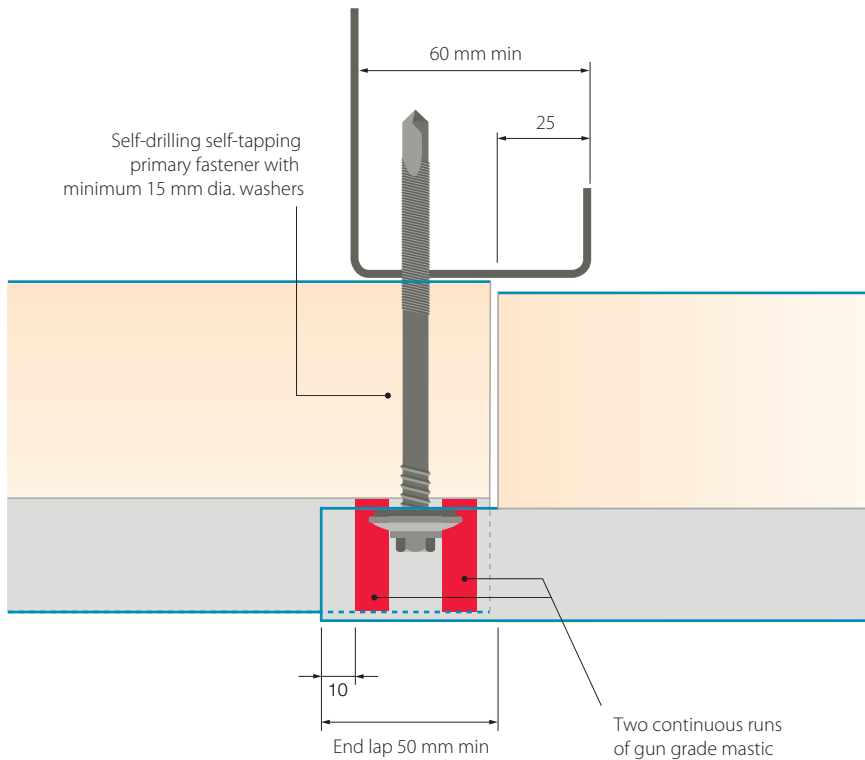

### End lap

Gun grade silicon sealant is used in the end laps to ensure the outer profiles nestle closely for improved aesthetics.

### Slab base drip

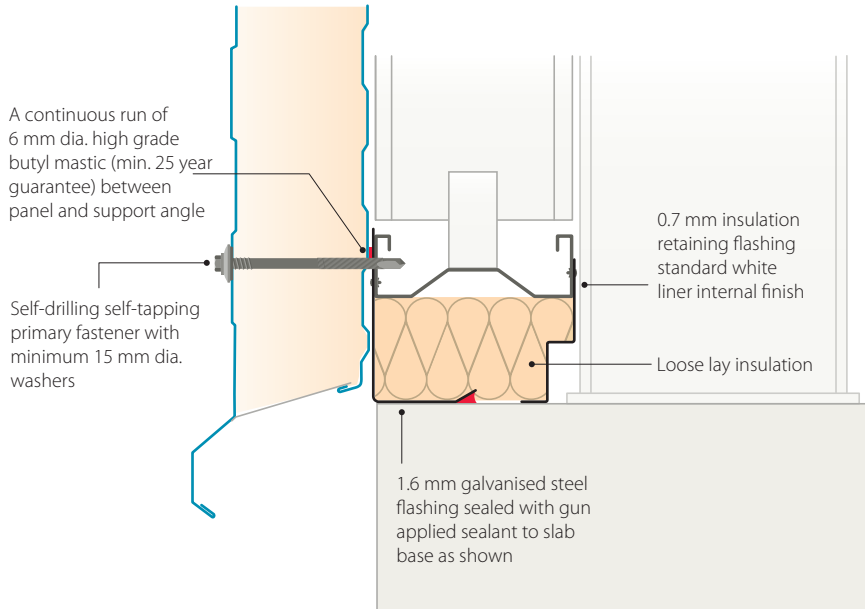

### Expansion joint

The 'V' formed flashing allows movement at this junction.

Psi value (W/mK)	f factor
0.024	0.972

Stated calculation results are dependant on components being as shown. Computer modelled in accordance with EN ISO 10211.

### Dado wall drip

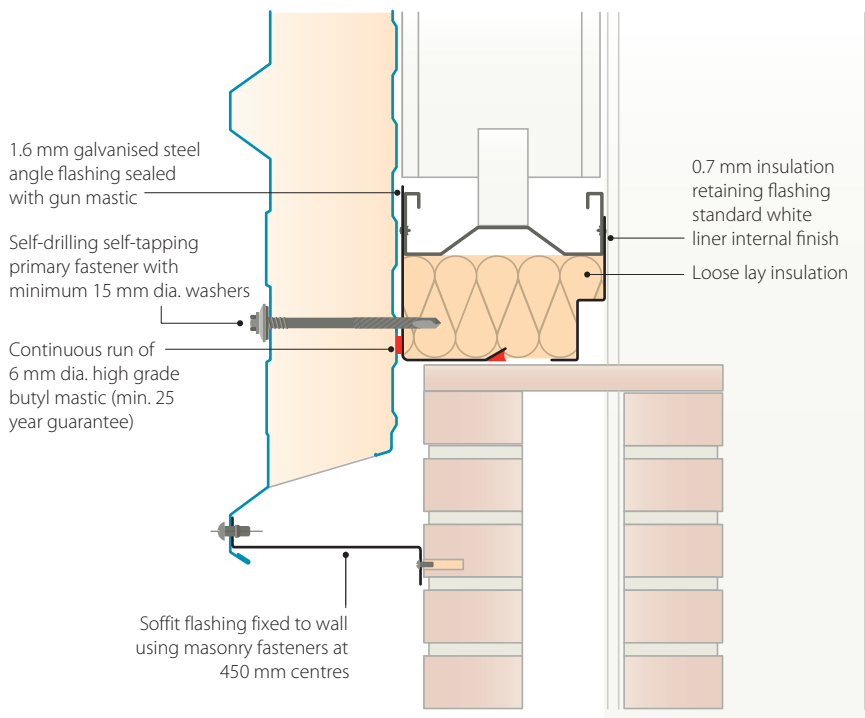

### Dado wall drip

The 1.6 mm galvanised steel support flashings should be fixed together prior to placement and securing to wall capping and bottom rail.

Psi value (W/mK)	f factor
0.484	0.702

Stated calculation results are dependant on components being as shown. Computer modelled in accordance with EN ISO 10211.

# Construction details – wall continued

## External corner

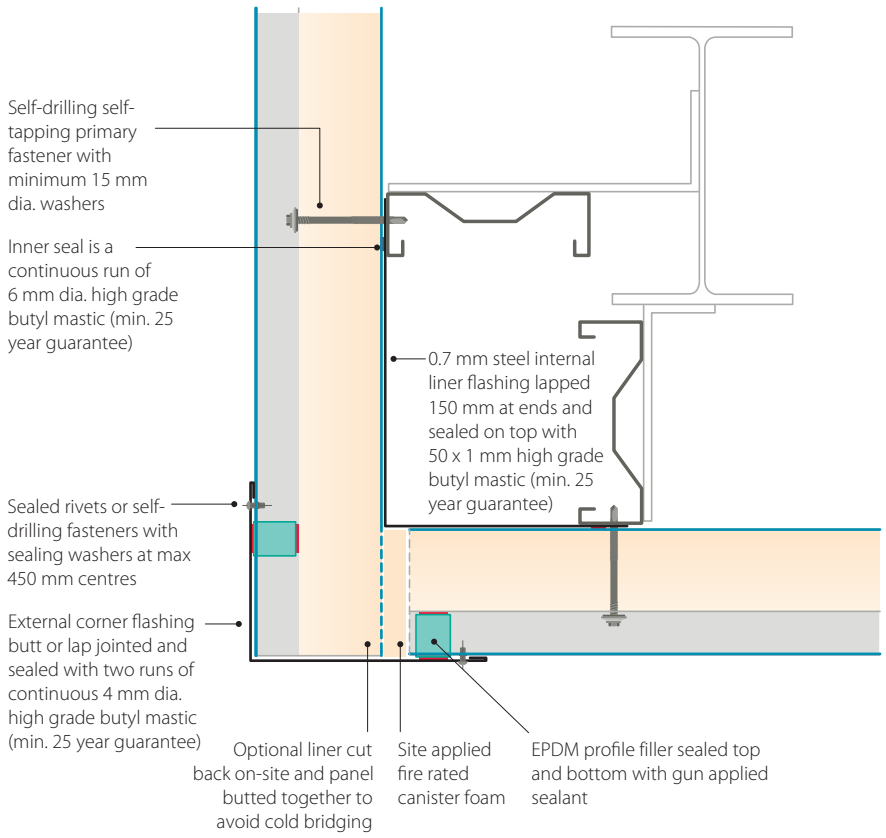

### External corner

Thermal performance can be enhanced by the on-site removal of the panel liner, within the corner junction, therefore reducing the risk of cold bridging. Running a circular saw to a depth of 15 mm at approximately 100 mm from the panel edge and then peeling the cut strip of steel away can easily remove the liner.

Psi value (W/mK)	f factor
With liner cut back	
0.041	0.957
Without liner cut back	
0.092	0.939

Stated calculation results are dependant on components being as shown. Computer modelled in accordance with EN ISO 10211.

## Internal corner

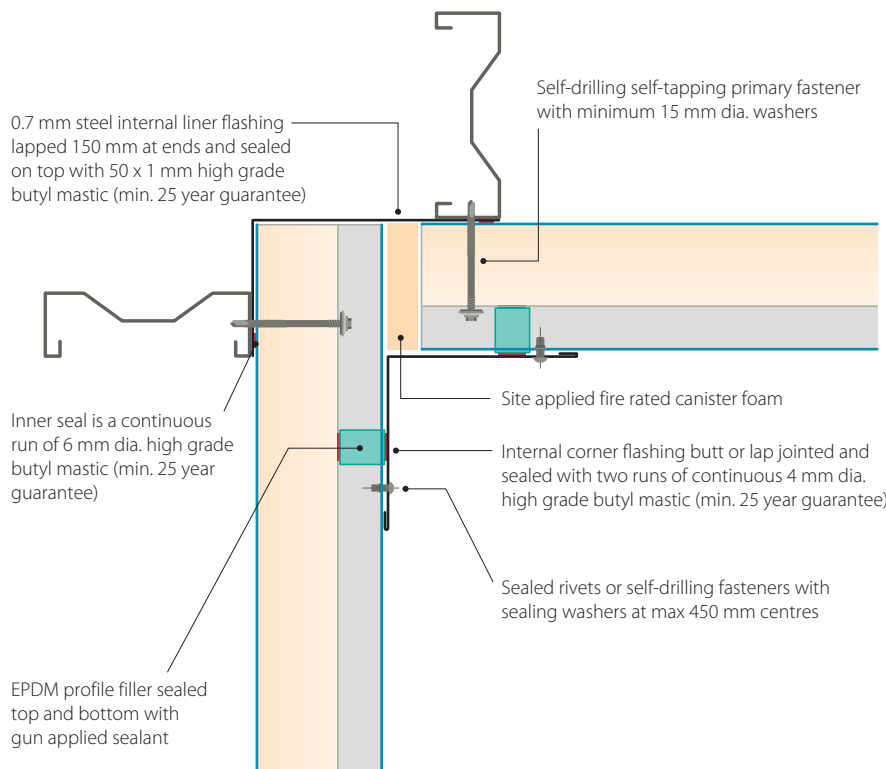

### Internal corner

Before fillers and outer flashing are applied, fire rated canister foam should be applied into the void between the panel end and the trough of the adjacent panel.

Psi value (W/mK)	f factor
With liner cut back	
0.019	0.940
Without liner cut back	
0.092	0.939

Stated calculation results are dependant on components being as shown. Computer modelled in accordance with EN ISO 10211.

### Window/door head

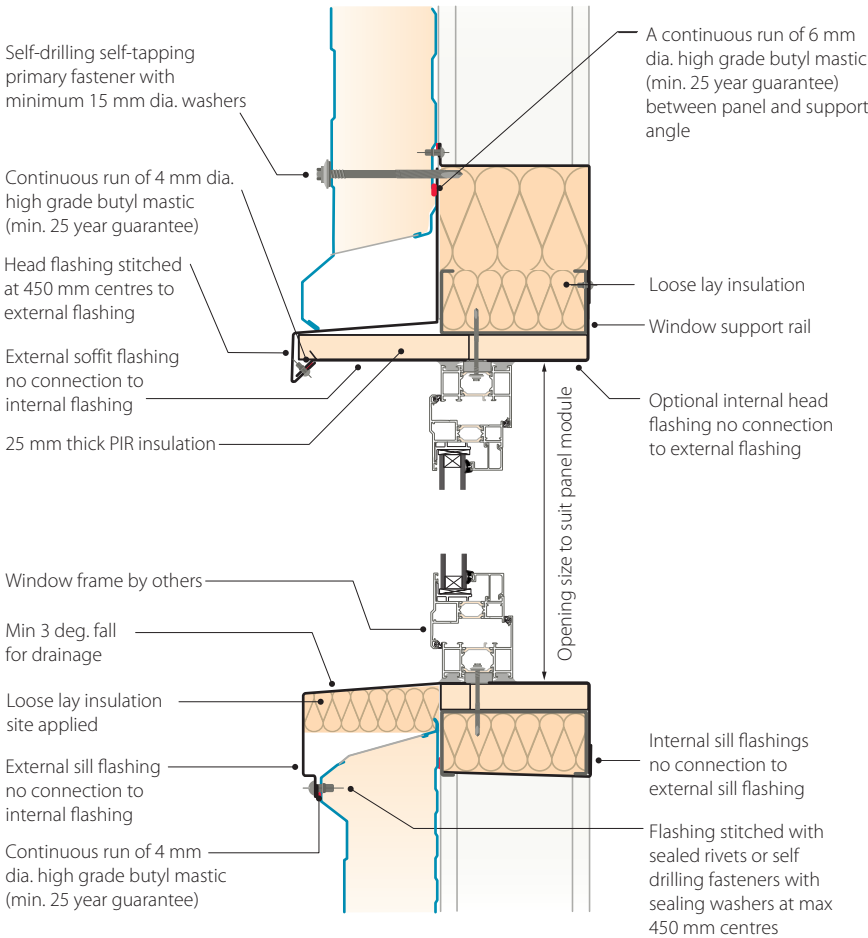

### Window/door head

This window flashing detail has been designed so that it can accommodate any proprietary window.

Psi value (W/mK)	f factor
0.614	0.735

Stated calculation results are dependant on components being as shown. Computer modelled in accordance with EN ISO 10211.

### Window sill

Psi value (W/mK)	f factor
0.613	0.878

Stated calculation results are dependant on components being as shown. Computer modelled in accordance with EN ISO 10211.

### Window/door jamb

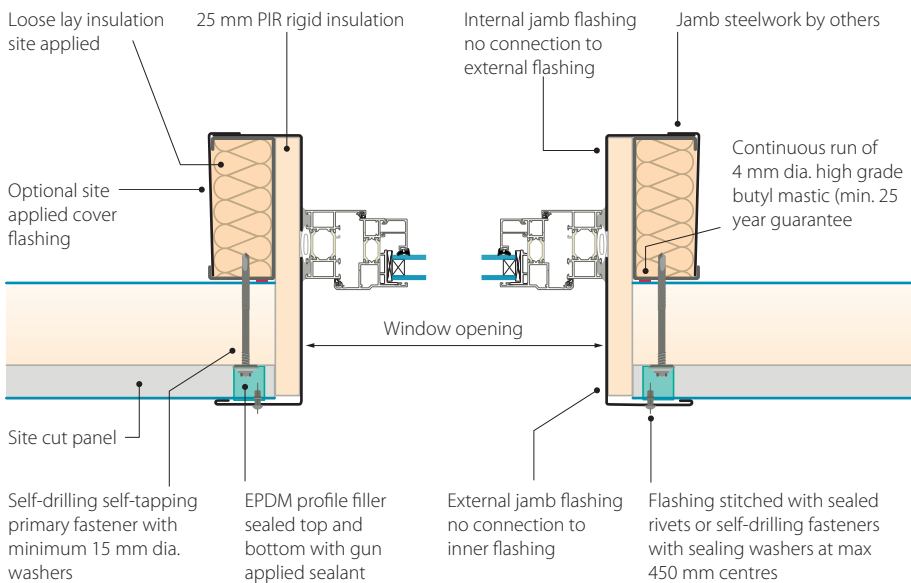

### Window/door jamb

Trimming steel work around the opening is required to support the window or door independent to the panels.

# Construction details – wall continued

## Horizontal to vertical break

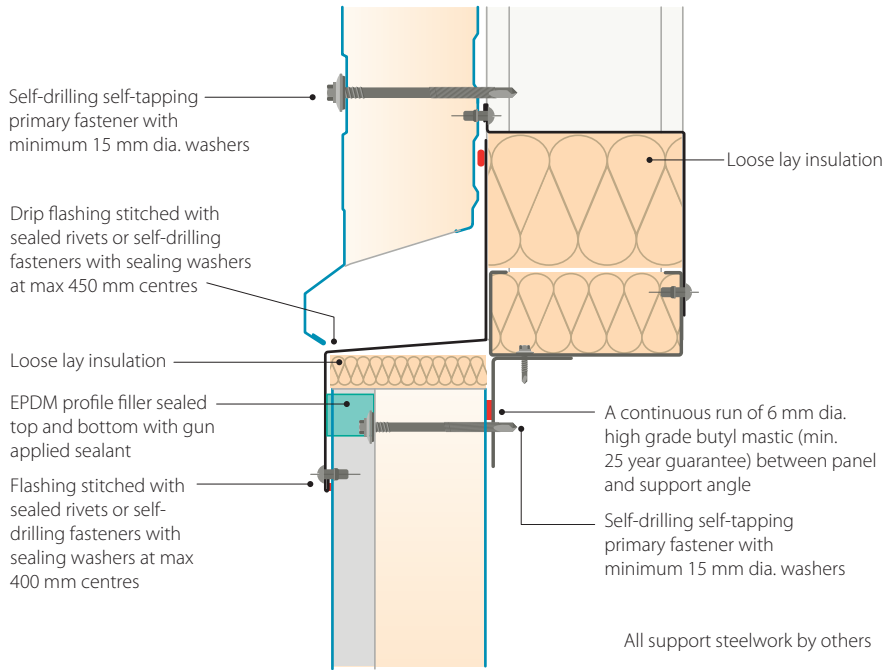

## Horizontal to vertical break

Horizontal and vertical panels can be installed adjacent to each other creating interesting architectural features, while the drip flashing detail still maintains thermal performance and an efficient weather seal.

Psi value (W/mK)	f factor
1.103	0.579

Stated calculation results are dependant on components being as shown. Computer modelled in accordance with EN ISO 10211.

## Brick wall abutment

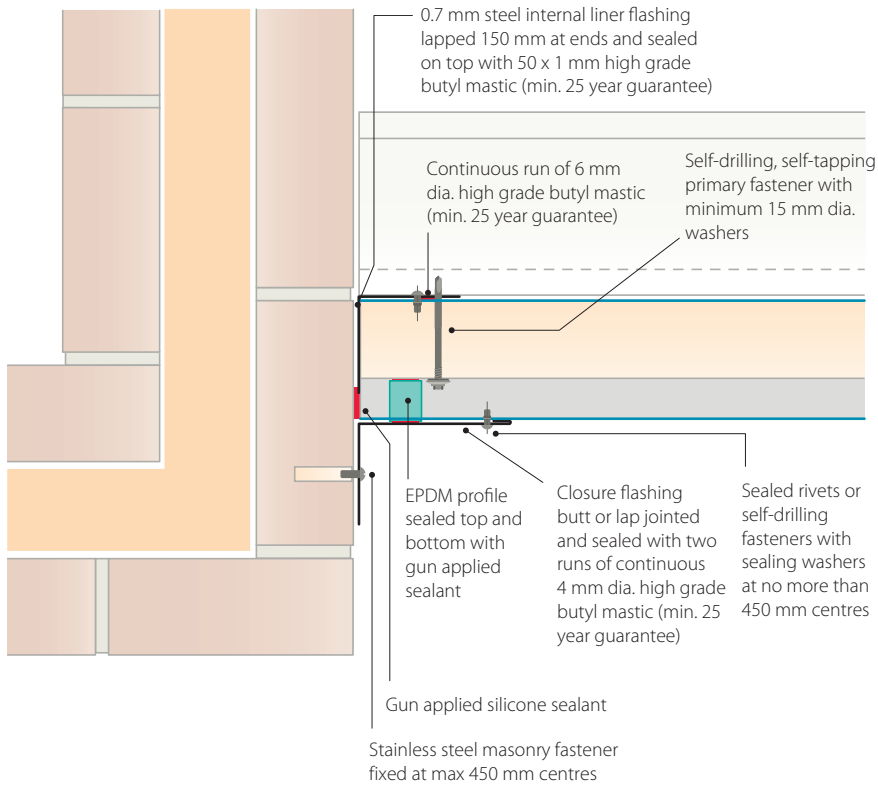

## Brick wall abutment

Masonry fasteners to be stainless steel to maintain the durability of the system.

Psi value (W/mK)	f factor
0.260	0.837

Stated calculation results are dependant on components being as shown. Computer modelled in accordance with EN ISO 10211.

# Fasteners, sealants and fillers

## Fastener selection table

### Primary fixing for Trisomet® (3-Rib) to steel purlins

Application	Panel core thickness (mm)	SFS intec Ltd	EJOT UK
Cold rolled purlins, Roof 1.2 - 5.0 mm Wall 1.3 - 3.0 mm	40	SXC5-S19-5.5 x 75 + COLOUR	CF19 JT3-D6H 5.5/6.3 x 67 + COLOUR
	60	SXC5-S19-5.5 x 95 + COLOUR	CF19 JT3-D6H 5.5/6.3 x 107 + COLOUR
	80	SXC5-S19-5.5 x 115 + COLOUR	CF19 JT3-D6H 5.5/6.3 x 127 + COLOUR
	100	SXC5-S19-5.5 x 135 + COLOUR	CF19 JT3-D6H 5.5/6.3 x 147 + COLOUR
	120	SXC5-S19-5.5 x 160 + COLOUR	CF19 JT3-D6H 5.5/6.3 x 167 + COLOUR
	135	SXC5-S19-5.5 x 193 + COLOUR	CF19 JT3-D6H 5.5/6.3 x 197 + COLOUR
Hot-rolled purlins, 4 – 14mm	40	SXC14-S19-5.5 x 80 + COLOUR	CF19 JT3-D12H 5.5/6.3 x 75 + COLOUR
	60	SXC14-S19-5.5 x 100 + COLOUR	CF19 JT3-D12H 5.5/6.3 x 95 + COLOUR
	80	SXC14-S19-5.5 x 120 + COLOUR	CF19 JT3-D12H 5.5/6.3 x 115 + COLOUR
	100	SXC14-S19-5.5 x 140 + COLOUR	CF19 JT3-D12H 5.5/6.3 x 155 + COLOUR
	120	SXC14-S19-5.5 x 165 + COLOUR	CF19 JT3-D12H 5.5/6.3 x 175 + COLOUR
	135	SXC14-S19-5.5 x 193 + COLOUR	CF19 JT3-D12H 5.5/6.3 x 195 + COLOUR
Side-lap stitcher	All	SL2-S-S14-5.5 x 25 + COLOUR	CF15 JT3-2-6.3 x 25 + COLOUR
Metal flashings to panel	All	SL2-S-S14-5.5 x 25 + COLOUR	CF15 JT3-2-6.3 x 25 + COLOUR

When fixing to timber, fastener pullout values may limit the ability of the roof to resist wind uplift loads. If in doubt, consult the Technical Department T: +44 (0) 1244 892199.

All fasteners can be sourced from: SFS intec Ltd, T: +44 (0) 113 2085 500 or EJOT UK Limited, T: +44 (0) 1977 687040.

## Fasteners

The primary fasteners for securing the Trisomet® roof panel to structural steel purlins have been purpose designed to facilitate speed of fixing, give this structural security with reduced risk of over compression, and have minimal thermal bridging. Time consuming pre-drilling of the panel or purlin is not necessary, as the high-thread fastener self-drills: the lower thread taps into the purlin and the higher thread taps into the outer skin, thereby clamping the panel securely in a single operation.

Side-lap stitching, should be at maximum of 450 mm centres. The stitcher can either be a painted sealed rivet, an integral nylon colour, or a powder coated headed austenitic stainless steel self-drilling fastener.

When a flashing needs to be secured to the panel, side lap fasteners can be used.

### Standard fastener layout at all support positions

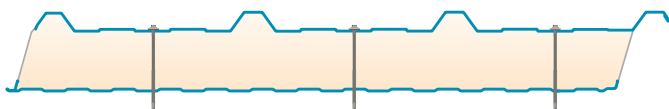

## Sealants and fillers

The end lap of Trisomet® requires three rows of 6 x 5 mm high grade butyl mastic (min. 25 year guarantee) this generally comes in rolls of 9.6 m with 30 rolls per box. (Wall end lap specifications vary see previous construction details).

Position the sealant in straight, unbroken lines, following the profile, taking care to avoid any stretch. Ensure the continuity and the effectiveness of the seal, especially at corners of sheets. The two lines of strip sealant must be placed between the sheets before fixing: two rows 10 mm from the sheet ends at the top and bottom of the lap.

The side lap of the panel is sealed with the same 6 x 5 mm sealant run continuously to weather side of the stitching fastener.

For panel ends at ridges and hips, black EPDM large flute profile fillers should be located between the panel's external skin and the cover flashing to provide continuity of weather seal and to prevent access by insects and small birds. These fillers should be sealed to top and bottom with gun applied solvent release bedding sealant.

All sealants can be sourced from the following suppliers:

- Premier Sealants (White strip), T: +44 (0) 1724 864100
- EJOT UK Limited (Blue Strip). T: +44 (0) 1977 687040
- SFS intec Ltd, (Pink Strip). T: +44 (0) 113 208 5500.

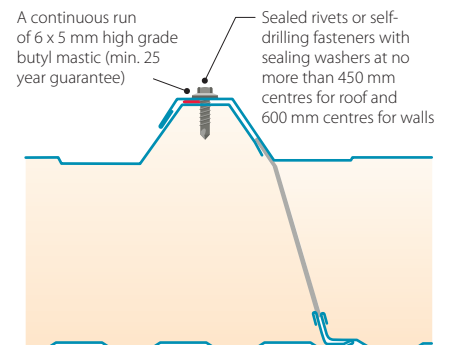

# Site guidance

This guide assumes that all current safety regulations are in place before the installers commence work.

## Maximum number of panels within a pack for varying panel lengths

Core thickness (mm)	Panel length (m)	No. of panels
40	2-7.5	19
	7.5-8	17
	8-9.5	15
	9.5-13	13
	13-16	9
	16-20	7
60	2-10	13
	10-11.5	11
	11.5-14.5	9
	14.5-18.5	7
	18.5-20	5
80	2-10	11
	10-13	9
	13-17.5	7
	17.5-20	5
100	2-12	9
	12-16	7
	16-20	5
120 & 135	2-16	7
	16-20	5

The above is based on interlocking stacking. Crown up stacking is available upon request, however this method of packing will reduce the number of panels in each pack.

## Packaging

The number of panels in each pack will vary with the length of the panel to ensure stability (see table left). Typically, panels are packed in stacks up to 1,100 mm high. The panels are protected at the base of the pack by timber pallets and are plastic wrapped in the factory. If required, panels can be grouped and referenced for particular areas of the building (eg, grid line, elevation reference). As standard, each pack is labelled with the order reference number, the number of panels and the panel length.

## Receipt of materials on-site

All materials arriving on-site must be checked promptly before off loading. Checks should be made against the relevant delivery notes to ensure that the correct quantities and specifications have been delivered and to determine any possible transportation damage. Any discrepancies or damage observed should be recorded immediately on the proof of delivery paperwork, and a written report should be submitted within 7 days. Please note that off loading is the customer's responsibility.

## Off loading

Wherever possible, Trisomet® should be off-loaded directly from the vehicle to the area where they will be used to reduce the risk of on-site damage. If loading directly on to a roof all packs should be unwrapped at ground level, base pallets removed and pack re-strapped before lifting onto the roof, to avoid the potential of pallets dropping between purlins. Off loading is to be undertaken as per Tata Steel recommendations. If panels are to be stored before installation, they should be placed on level ground (in accordance with storage instructions opposite).

There are two recommended methods for off loading:

- **Forklift or telehandler:** These can be used when off loading panels less than 6 m long. Care must be taken not to tip or damage the bottom panel when driving on uneven ground. Only one pack at a time should be unloaded. Open forks fully before lifting.
- **Crane:** Where slings or grabs are used, precautions should be taken to prevent edge damage and to avoid pressure across the panels, which may cause distortion (chains should not be used). When lifting panels over 6 m long, a spreader bar with sufficient hoisting belts to spread the load should be used. If required, temporary edge protection can be installed to prevent local damage. Only one pack at a time should be off-loaded.

## Packaging: Stacked panels

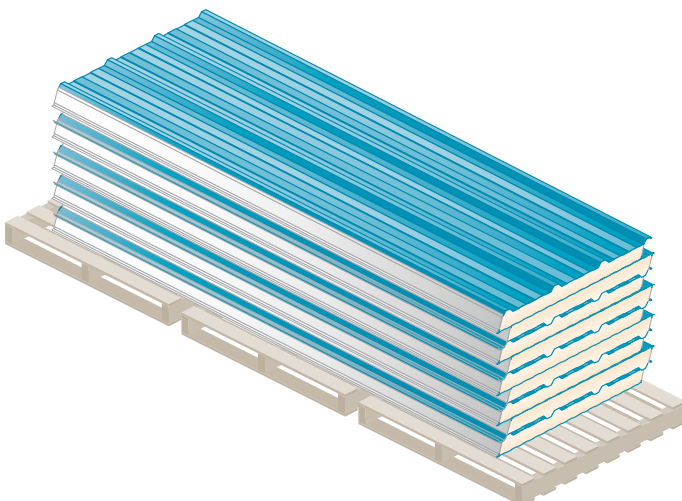



## Storage

In addition to the guidelines above, the bundles should be stored on level ground (eg, a floor slab). The packs should never be stacked more than two high. There should be adequate separation between stacks to provide access and to avoid end damage.



1. Do not stand uncovered stacks in the open. Store under cover and away from open doorways.



2. If stacks cannot be stored under cover, erect a simple scaffold around them and cover it with a waterproof sheet, tarpaulin or polythene. Leave space between the cover and stacks to allow air to circulate.



3. Store stacks off the ground and on a slope, so that if rain penetrates the cover, the water will drain away.



4. Inspect the storage site regularly to ensure that moisture has not penetrated the stack.



5. Do not store sheets where people will walk across them.

## Pre-erection checks

A secondary support structure is required to support the cladding system at the necessary positions and transfer all loads imposed on and by the cladding system back to the primary structure.

Before any work starts, a full survey or inspection should be carried out to ensure that the support steelwork and any other associated materials, is correctly positioned and within tolerance so that Trisomet® can be fixed correctly. Any obvious problems should be immediately reported to the main contractor to enable remedial work to be undertaken before installation of the cladding.

Tata Steel recommends the allowable variation in the outer flange level of the purlin/rail with respect to the datum line is  $L/400$  (where L is the rail spacing).

Further guidance on steel work tolerance can be found in a Steel Construction Institute publication P346: *Best Practice for the specification in installation of metal cladding and secondary steelwork*.

## Handling

Wherever possible, manual handling should be avoided and mechanical handling equipment should be used. Mechanical handling provides health and safety benefits, shorter installation times, smaller installation teams and less risk of panel damage.

## Recommended suppliers

GGR Cladding

T: +44 (0) 161 683 2580

4 Cladding Services

T: +44 (0) 870 7417600

## Cutting

For making small cut-outs, openings and cuts that are not straight, use a jigsaw or a reciprocating saw. For longer straight cuts we recommend using a circular saw that produces a cold cut with a fine-tooth metal cutting blade (ie, not a grinding blade, as this hot cut will damage the coating). All cutting should be undertaken at ground level.



# Roof installation

## Installation: Roof Panel

The steps given below are instructions for a typical construction and should be used only as a guide. Specific technical details, method statements and site-specific risk assessments should be produced and applied for each building. An extended list of construction details is available from Tata Steel, and advice can be given via our technical department on any bespoke details that may be required.

The following steps apply to a roof made up of multiple panels with end lap joints. Wherever practical, panels of the same length from ridge to eaves should be used to avoid end laps. This provides a cleaner finish and a more economical installation.

1. Carry out preparation work on internal ridge, internal eaves, trims, etc, and ensure that these are lined and levelled and sealed as specified. Lay down air seals onto the top flange of the eaves beam and the ridge purlins.
2. Position the eaves (or bottom) corner panel, and ensure it is correctly aligned and lapping in the right direction. Wherever possible, the panels should be laid with the exposed joints of the side laps facing away from the prevailing wind (see Figure 1). Fix the panel using primary fasteners in the trough of the trailing edge. Make sure the fasteners are not over tightened and clean away drilling swarf to avoid rust marks.
3. Ensuring that the top of the lower panel (panel 1) is clean and dry, apply three rows of sealant across the panel width with a strip of sealant at the underlap position as shown in the illustration on the next page. The first seal should be placed above the fixing line, the second directly below and the third 10 mm from the end of the specified lap (150 mm recommended). The seal should be carefully applied to ensure coverage in the corners of the profile.

### First panel laid

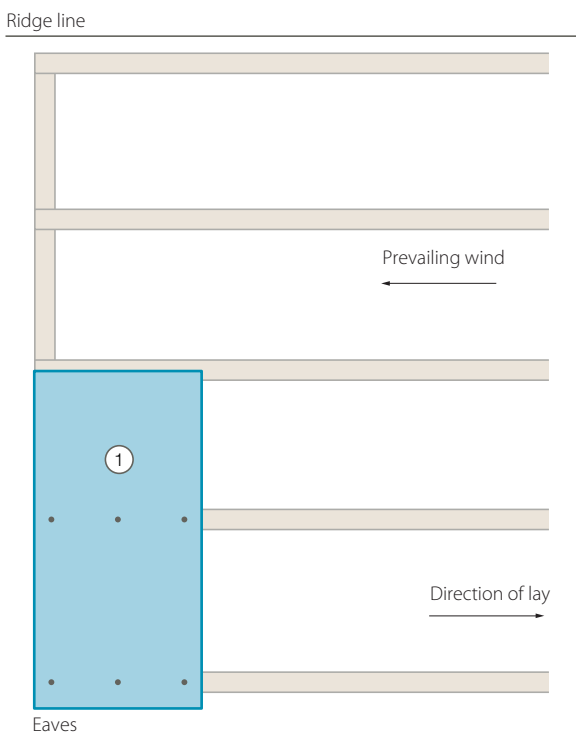

### Second panel laid

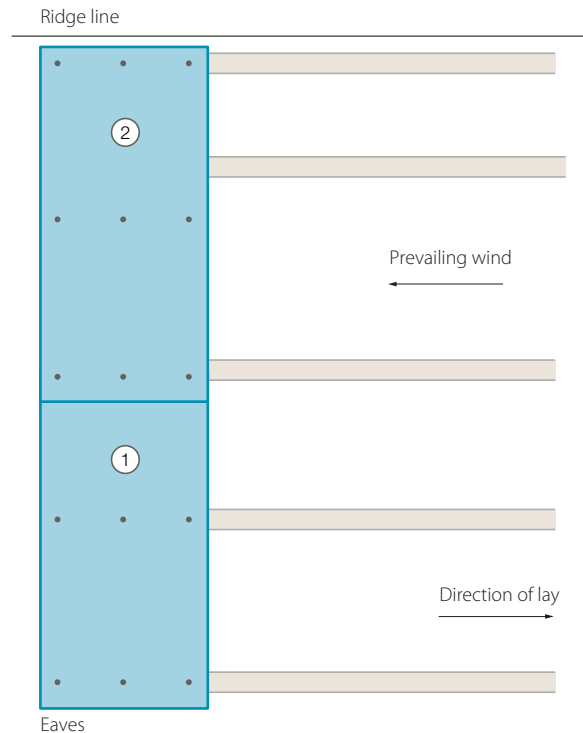

### End lap with three rows of sealant

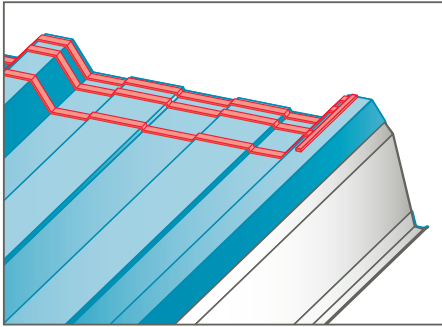

### Side lap

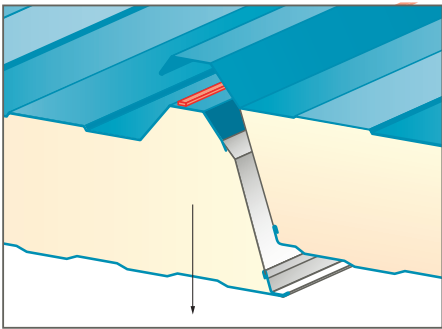

4. Ensure that the cutback of panel 2 is clean and dry before positioning the panel over panel 1. Be careful not to disturb the seals. Align the profiles of the two panels before securing at specified fastener layout.
5. Run the side lap seal continuously from ridge to eaves ensuring this is placed to the weather side of the side lap. Side lap panel 3 by dropping panel into position and securing with specified fastener layout.
6. Apply the end-lap seals as described in step 3.
7. Ensure that the cutback of panel 4 is clean and dry. Position the end of panel 4 over panel 3 and drop down the Side lap as before. Ensure that the profiles of the two panels are aligned before securing into the purlins. Secure the side lap using sealed rivets or stitching screws at a minimum of 450mm centres.
8. Continue steps 5, 6 and 7 until the elevation is complete. Seal and position profile fillers at ridge and fit the external flashings and ensure they are sealed as specified.

### Third panel laid

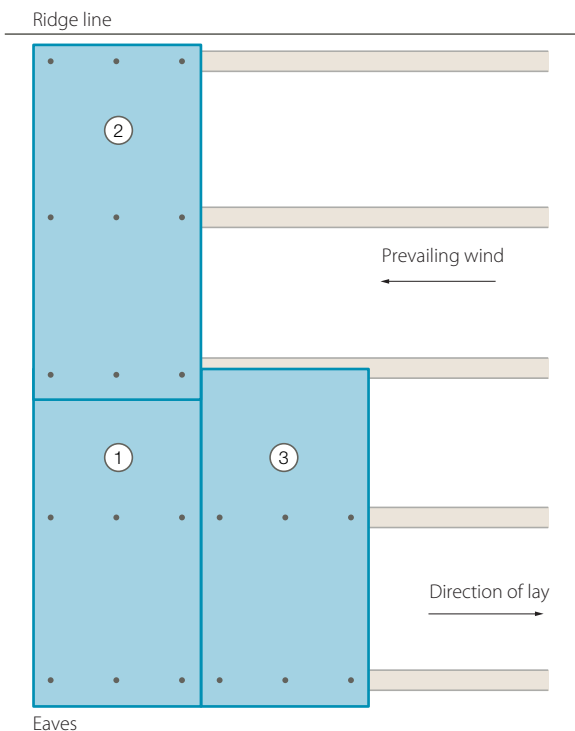

### Fourth panel laid

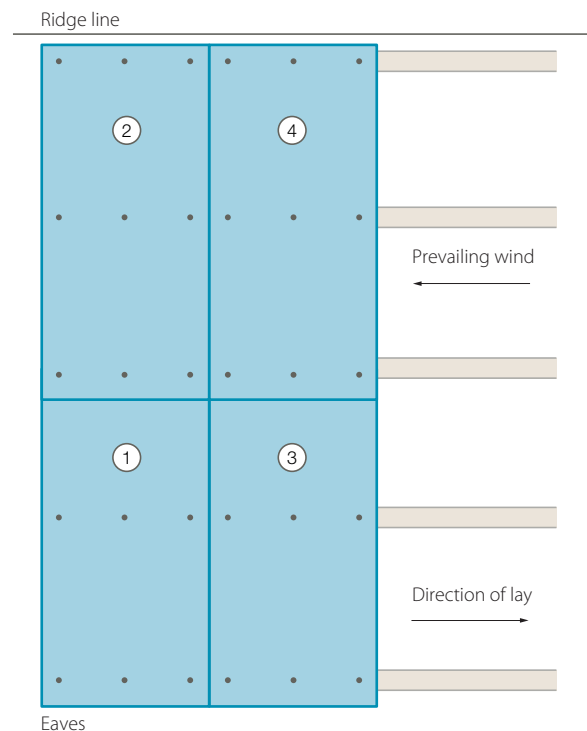

# Wall installation

## Installation: Wall panel

The steps given below are instructions for a typical construction and should be used only as a guide. Specific technical details, method statements and site-specific risk assessments should be produced and applied for each building. An extended list of construction details is available from Tata Steel and advice can be given via our Technical Department on any bespoke details that may be required.

The following steps apply to a wall made up of multiple panels with one end lap joint. Wherever practical panels of the same length from base level to eaves should be used to avoid end laps. This provides a cleaner finish and a more economical installation.

## Vertical wall installation

1. Checks should be carried out to make sure that the bottom rail is adequately supported and level along its full length before commencing installation work.
2. Carry out preparation work on sill trims and the base support angle for the first panel, and ensure these are lined, levelled and sealed as specified (see page 30 of construction details).
3. Hoist the first panel and position on the support angle with the overlap edge adjacent to the corner. Before inserting the fasteners, ensure that:
  - a. The setting out dimensions are observed. Failure to comply with these dimensions may lead to problems later in the section.
  - b. The panel is plumb using a plumb line.
  - c. The position of the panel relative to the bottom and top or intermediate rails is correct. Check this with the erection drawings.
4. Fix the panel using primary fasteners as specified. Make sure the fasteners are not over tightened, and clean away drilling swarf to avoid rust marks.
5. Ensure that the top of the lower panel (ie, panel 1) is clean and dry, and then apply the two rows of sealant across the panel width in positions as shown. The first seal should be placed above the fixing line, the second between 10 mm from the end of the specified lap (75 mm recommended). The seal should be carefully applied to ensure coverage in the corners of the profile.

### First panel laid

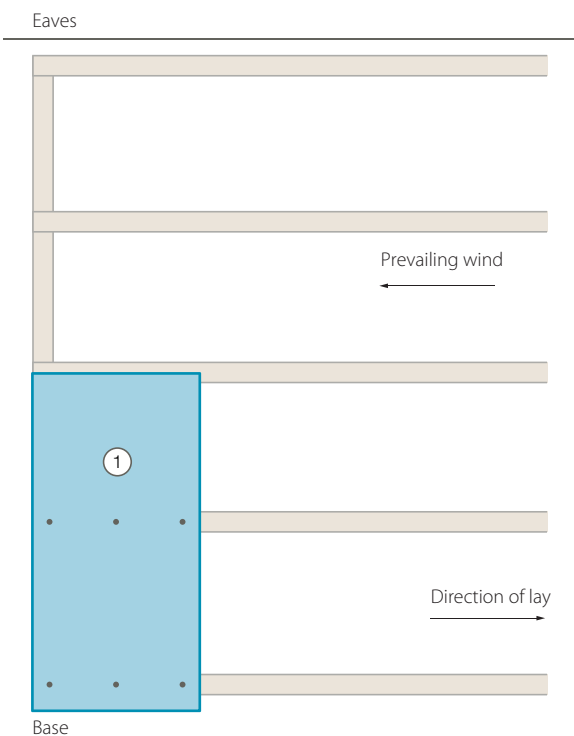

### Second panel laid

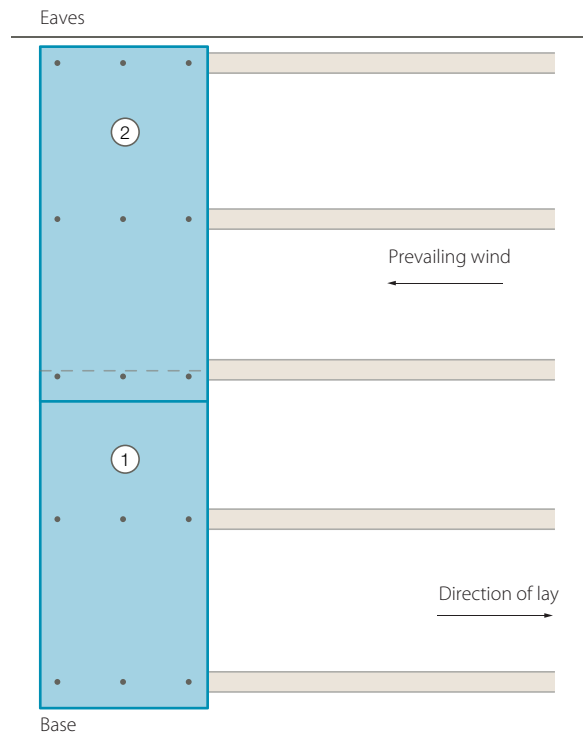

### End lap with three rows of sealant

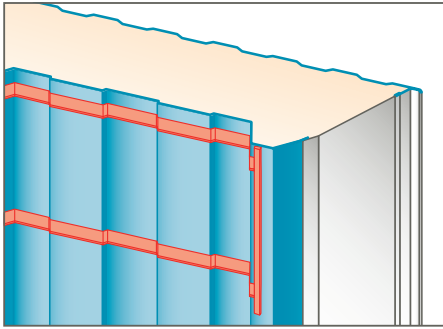

6. Ensure the cutback of panel 2 is clean and dry before positioning the panel over panel 1, as shown. Be careful not to disturb the seals. Align the profiles of the two panels before securing.
7. Run the side lap seal continuously from eaves to base ensuring this is placed to the weather side of the side lap. Side lap panel 3 and secure with specified number of fasteners.
8. Apply the end-lap seals to panel 3 as shown.
9. Ensure that the cutback of panel 4 is clean and dry. Position the end of panel 4 over panel 3 and side lap as before. Ensure that the profiles of the two panels are aligned before securing into the rails. Secure the side lap using sealed rivets or stitching screws at a minimum of 600 mm centres.
10. Continue steps 5 to 9 until the elevation is complete. Fit the external flashings and ensure they are sealed as specified.

### Side lap

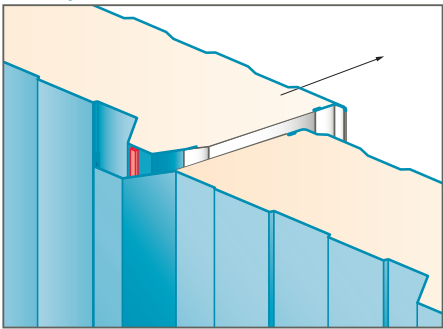

8. Apply the end-lap seals to panel 3 as shown.

### Third panel laid

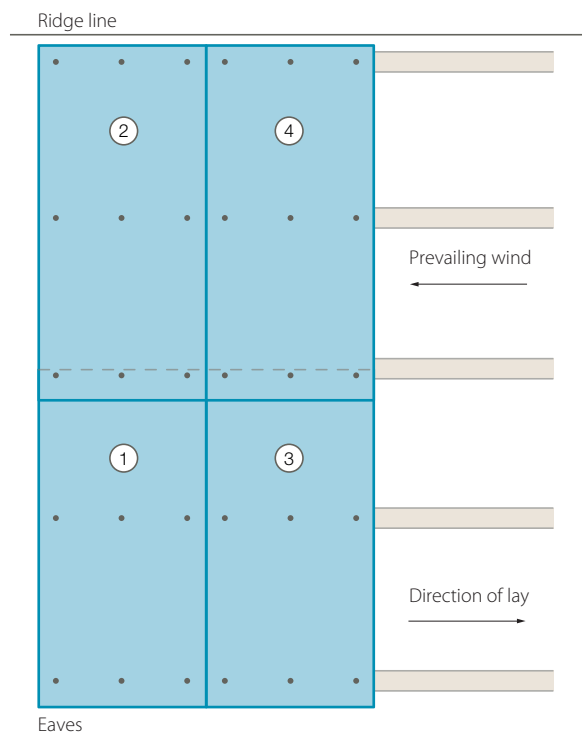
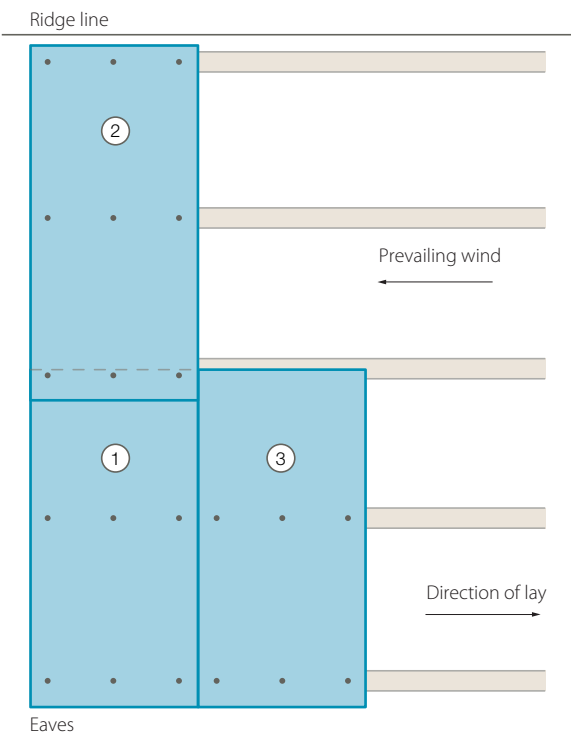

# Wall installation continued

## Horizontal wall installation

The following steps apply to a wall made up of multiple panels with one end lap joint between the corners of the elevation. For elevations containing more than one end lap ensure that each horizontal level of panels is complete before starting the row above.

When running panels horizontally on a wall elevation, care must be taken when ordering the handing of the product. The standard vertically laid left-to-right handed panels will run right-to-left when installed horizontally as shown below.

1. Carry out preparation work on sill trims. Ensure that these are lined, levelled and sealed as specified (see page 35 of construction details).
2. Temporarily support base panel and secure with one fastener. Recheck level and the bearing dimensions, on vertical supports, are correct before fully securing with specified number of fasteners. Ensure the fasteners are not over tightened, and clean drilling swarf from the rib ledge to avoid rust marks.
3. Ensuring that the end of the first panel is clean and dry, apply two rows of gun-grade silicone sealant across the full width of the panel in positions as shown. The first seal should be placed behind the fixing line, and the second 10 mm from the end of the specified lap (50 mm recommended).

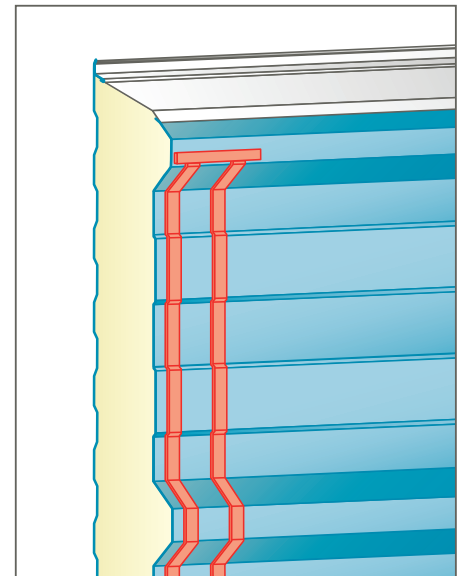

## First and second panel laid – Vertical wall

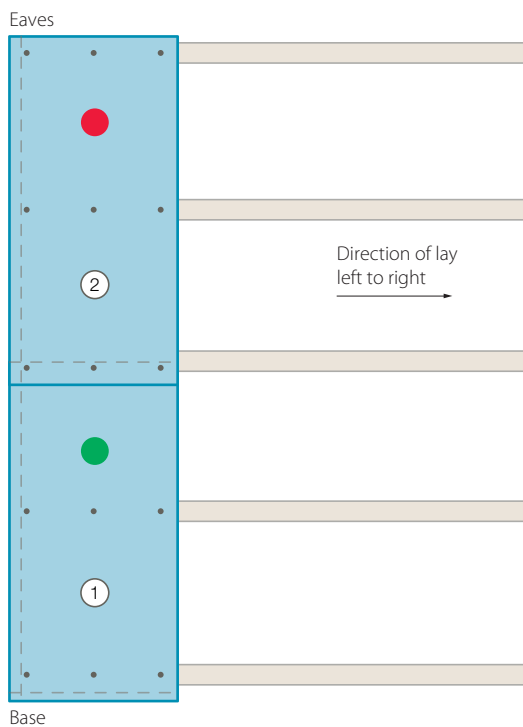

NB. Care must be taken when ordering product handing for horizontal wall installations.

## First and second panel laid – Horizontal wall

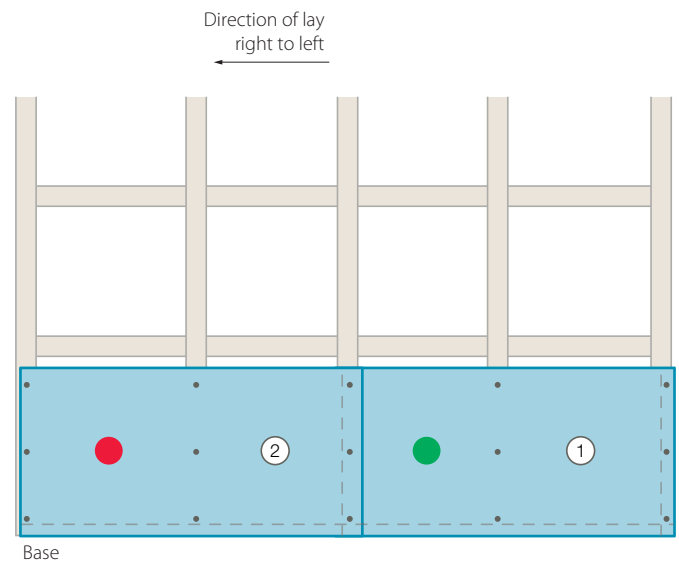

4. Ensure the cutback of panel 2 is clean and dry before positioning the panel over panel 1. Ensure that the profiles of the two panels are aligned before securing them to the vertical cladding rails using the recommended number of fasteners.
5. Run the side lap seal continuously to the bottom row of panels ensuring this is placed to the weather side of the side lap. Side lap panel 3 and secure with specified number of fasteners.
6. Apply the end-lap seals to panel 3 as shown.

7. Ensure that the cutback of panel 4 is clean and dry. Position the end of panel 4 over panel 3 and side lap as before. Ensure that the profiles of the two panels are aligned before securing into the rails. Secure the side lap using sealed rivets or stitching screws at a minimum of 600 mm centres.
8. This procedure should be continued along the full width of the elevation before starting the second row of panels. Continue row by row until the elevation is complete. Fit the external flashings, and ensure they are sealed as specified.

Side lap

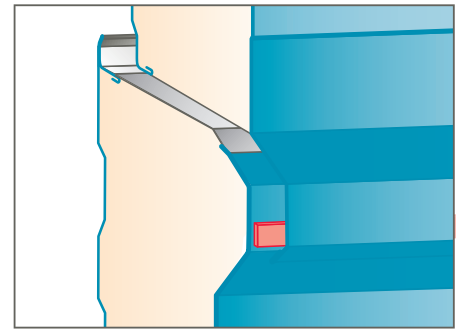

### Removal of protective film

Trisomet® can be supplied with protective film on the external face. This is designed to provide additional protection during manual handling and site fixing. The film has a limited shelf life and must not be exposed to sunlight for long periods because it is susceptible to ultraviolet degradation. This makes the film difficult to remove and may result in adhesive residue that causes dust and dirt to adhere to the decorative finish. To ensure easy, clean removal, remove the film within one month of panel delivery to site.

Third panel laid

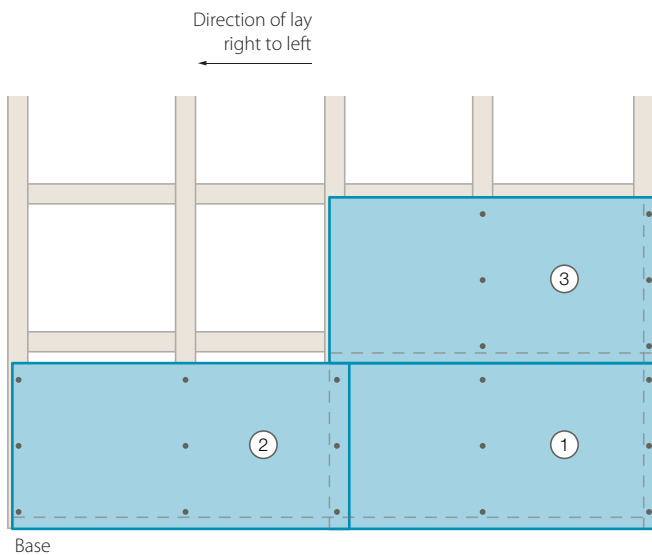

Fourth panel laid

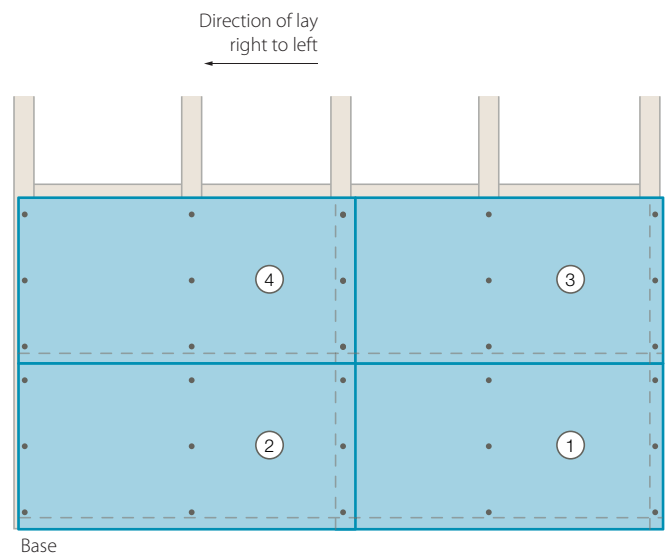

[www.tatasteelconstruction.com](http://www.tatasteelconstruction.com)

**Trademarks of Tata Steel UK Limited**

Colorcoat, Colorcoat Connection, Colorcoat HPS200 Ultra, Colorcoat Prisma, Confidex, Galvalloy, Platinum Plus, Trimapanel and Trisomet are registered trademarks of Tata Steel UK Limited.

Care has been taken to ensure that the contents of this publication is accurate, but Tata Steel Europe Limited and its subsidiaries, (including Tata Steel UK Limited), do not accept responsibility or liability for errors or information that is found to be misleading. Suggestions for, or descriptions of, the end use or application of products or methods of working are for information only and Tata Steel Europe Limited and its subsidiaries accept no liability in respect thereof.

Before using products or services supplied or manufactured by Tata Steel Europe Limited and its subsidiaries, customers should satisfy themselves as to their suitability.

Copyright 2017 Tata Steel.

**Tata Steel**

Shotton Works

Deeside

Flintshire

CH5 2NH

T: +44 (0) 1244 892199

F: +44 (0) 1244 892121

[www.tatasteelconstruction.com](http://www.tatasteelconstruction.com)

Tata Steel UK Limited is registered in England under number 2280000, with registered Office at 30 Millbank London SW1P 4WY.

Language English 0317